

**PROFILED PANEL SYSTEM**

**NOTE:**  
**LOAD BEARING WALL COMPONENTS OF EITHER: 16GA STEEL STUDS, STRUCTURAL MEMBERS, MINIMUM 3/4" PLYWOOD OR CONCRETE. GYPSUM BOARD AND CEMENT BOARD ARE NOT A STRUCTURAL COMPONENT.**

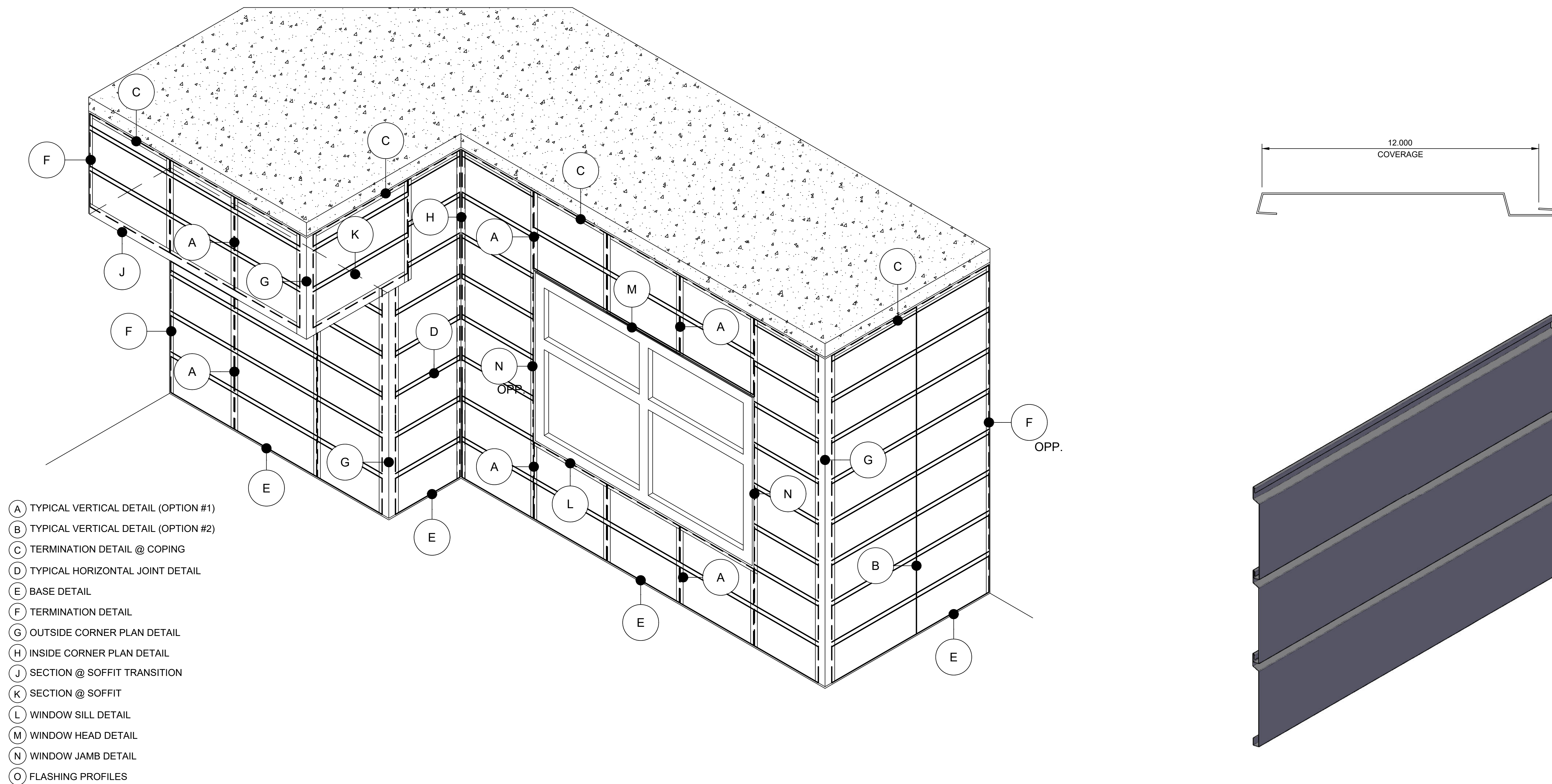

TYPICAL VERTICAL DETAIL (OPTION #1)

DETAIL A

**NOTE:**  
 LOAD BEARING WALL COMPONENTS OF EITHER: 16GA STEEL STUDS, STRUCTURAL MEMBERS, MINIMUM 3/4" PLYWOOD OR CONCRETE. GYPSUM BOARD AND CEMENT BOARD ARE NOT A STRUCTURAL COMPONENT.

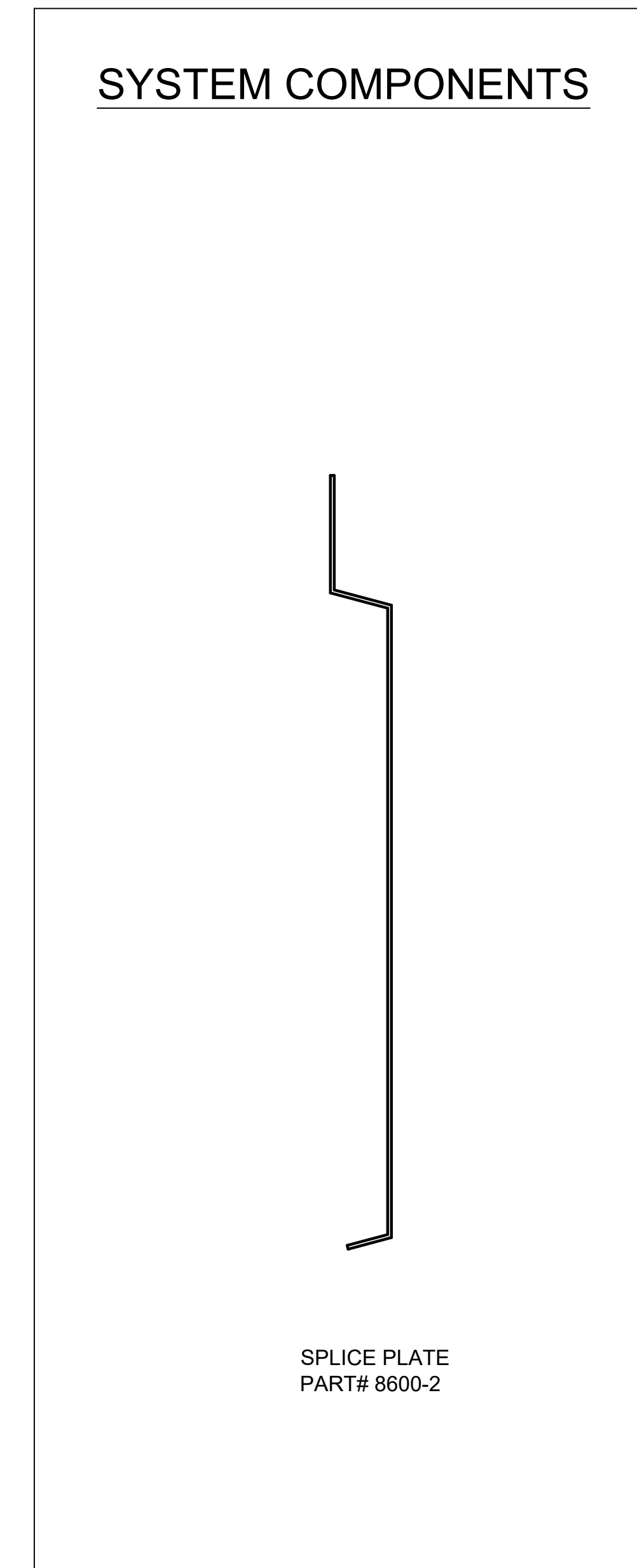
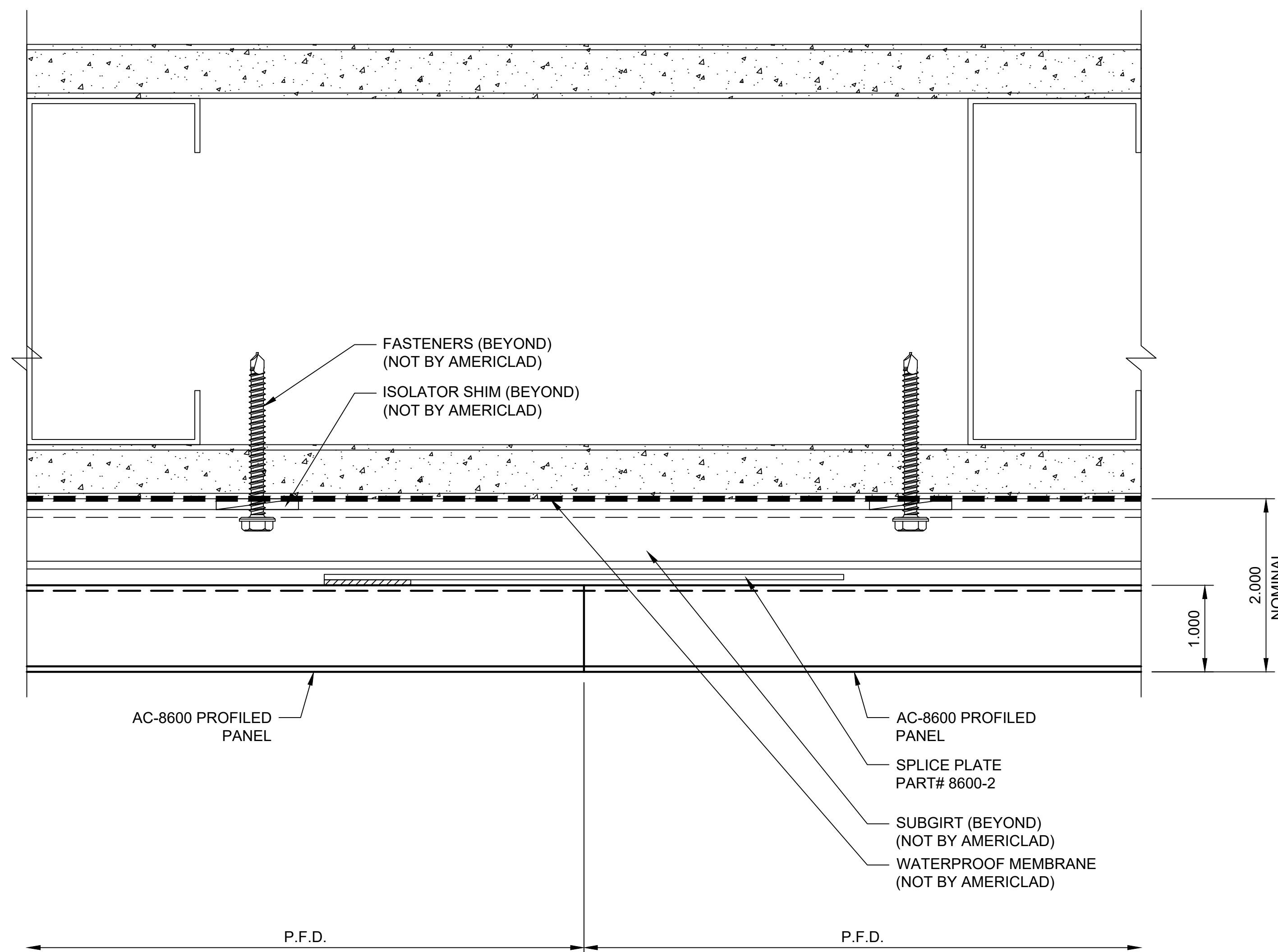

NOTE: SPLICE PLATE SHOWN N.T.S.

TYPICAL VERTICAL DETAIL (OPTION #2)

DETAIL B

**NOTE:**  
 LOAD BEARING WALL COMPONENTS OF EITHER: 16GA STEEL STUDS, STRUCTURAL MEMBERS, MINIMUM 3/4" PLYWOOD OR CONCRETE. GYPSUM BOARD AND CEMENT BOARD ARE NOT A STRUCTURAL COMPONENT.

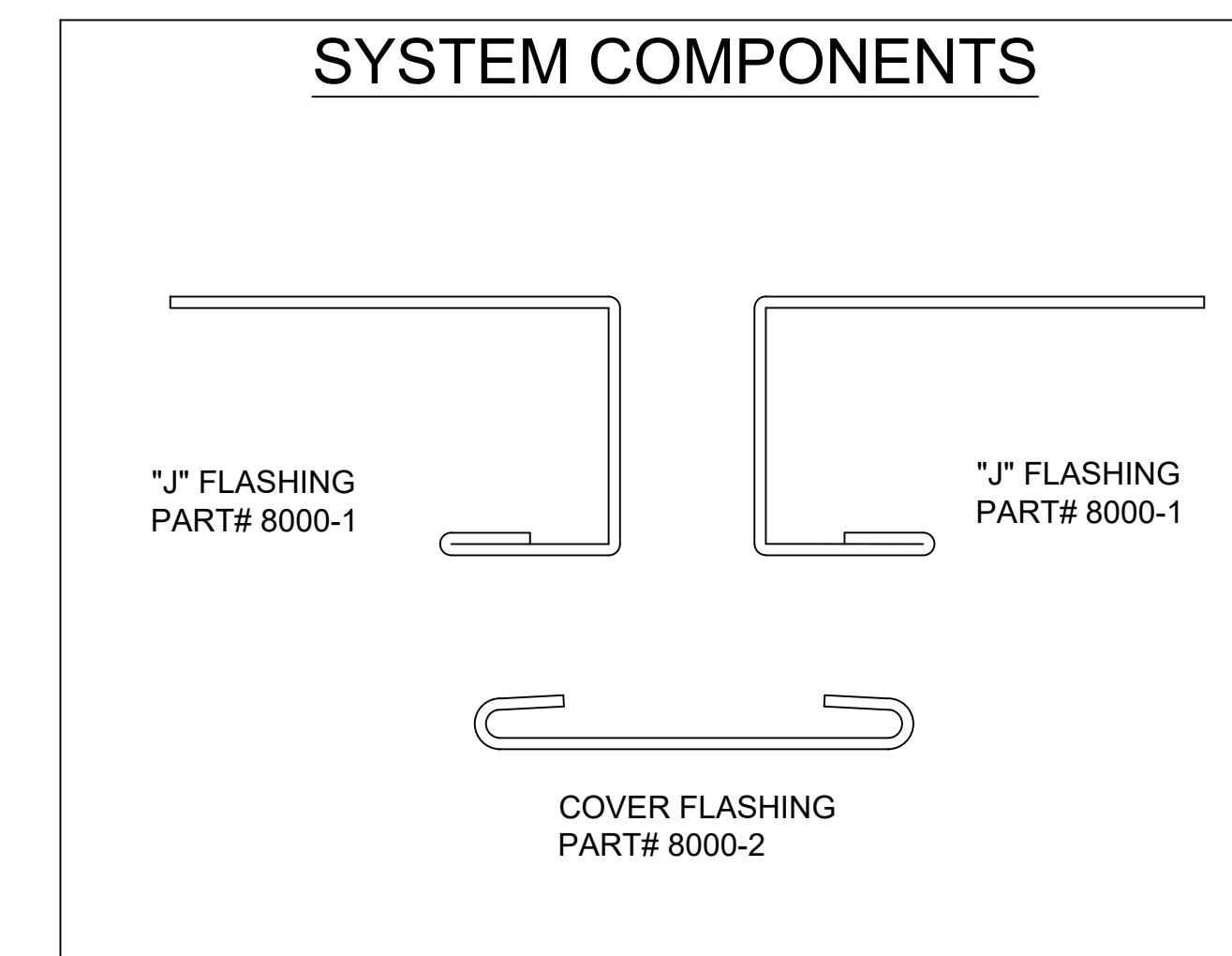
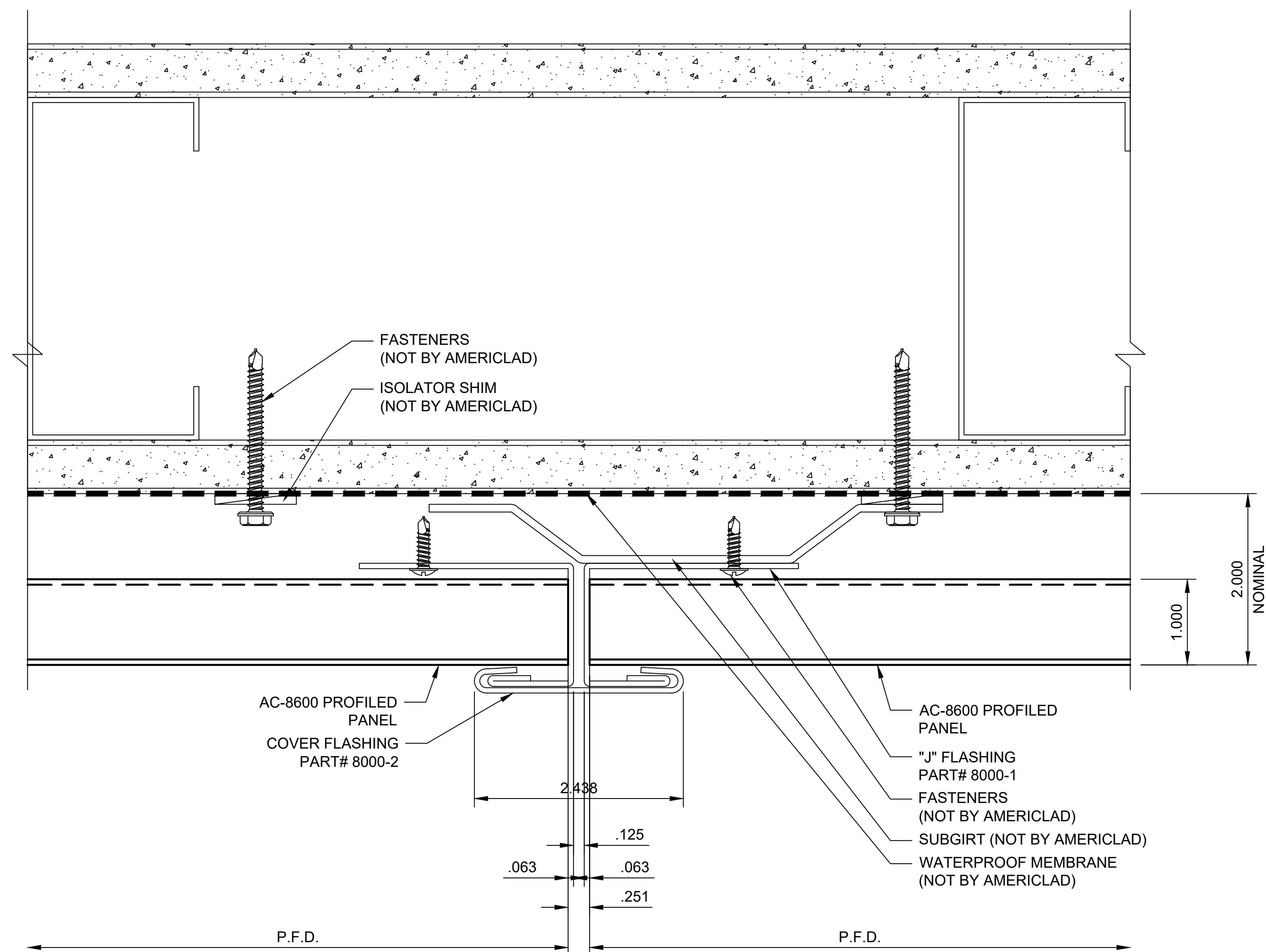

TERMINATION DETAIL @ COPING

DETAIL C

**NOTE:**  
LOAD BEARING WALL COMPONENTS OF EITHER: 16GA STEEL STUDS, STRUCTURAL MEMBERS, MINIMUM 3/4" PLYWOOD OR CONCRETE. GYPSUM BOARD AND CEMENT BOARD ARE NOT A STRUCTURAL COMPONENT.

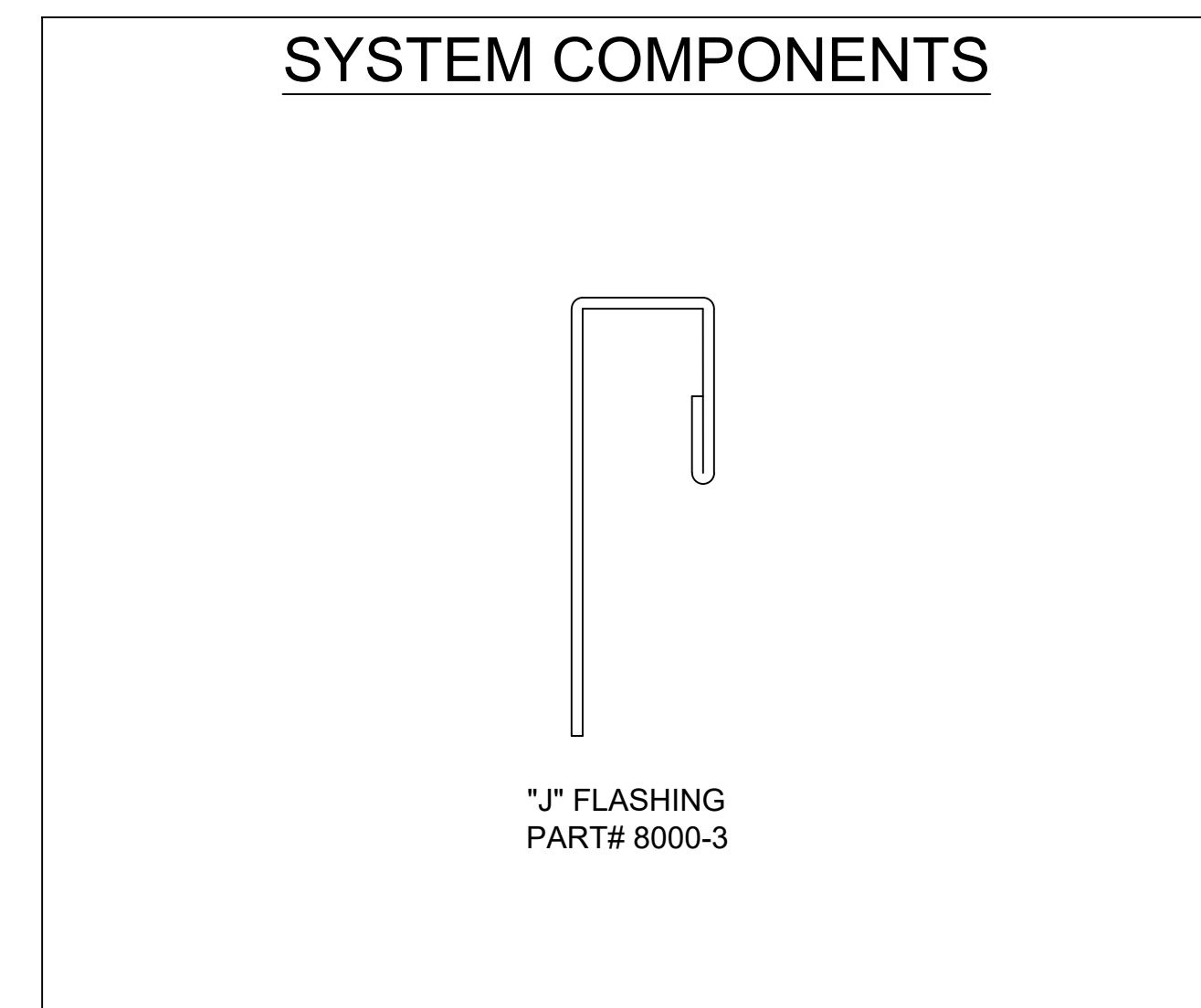
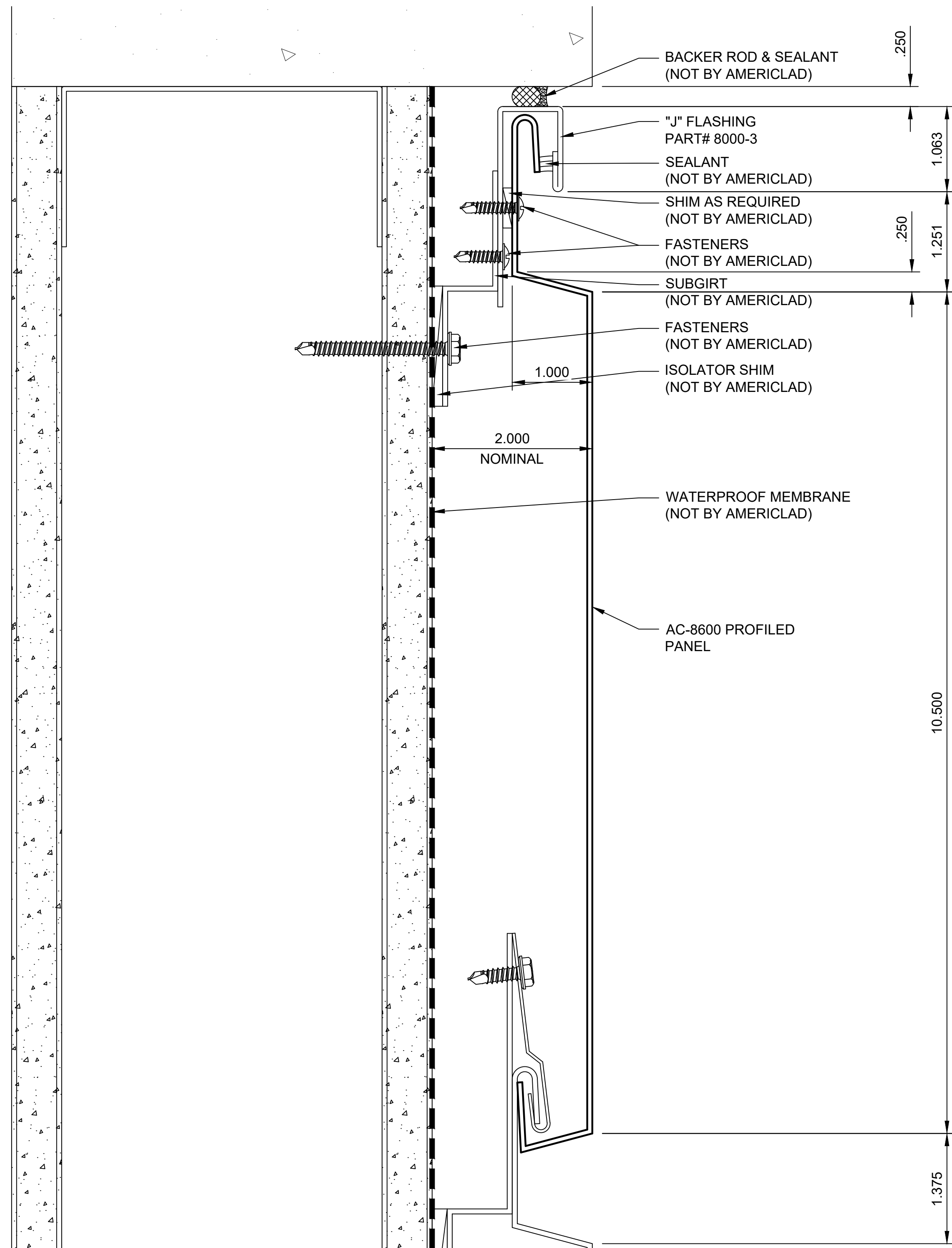

TYPICAL HORIZONTAL JOINT DETAIL

DETAIL D

**NOTE:**  
**LOAD BEARING WALL COMPONENTS OF EITHER: 16GA STEEL STUDS, STRUCTURAL MEMBERS, MINIMUM 3/4" PLYWOOD OR CONCRETE. GYPSUM BOARD AND CEMENT BOARD ARE NOT A STRUCTURAL COMPONENT.**

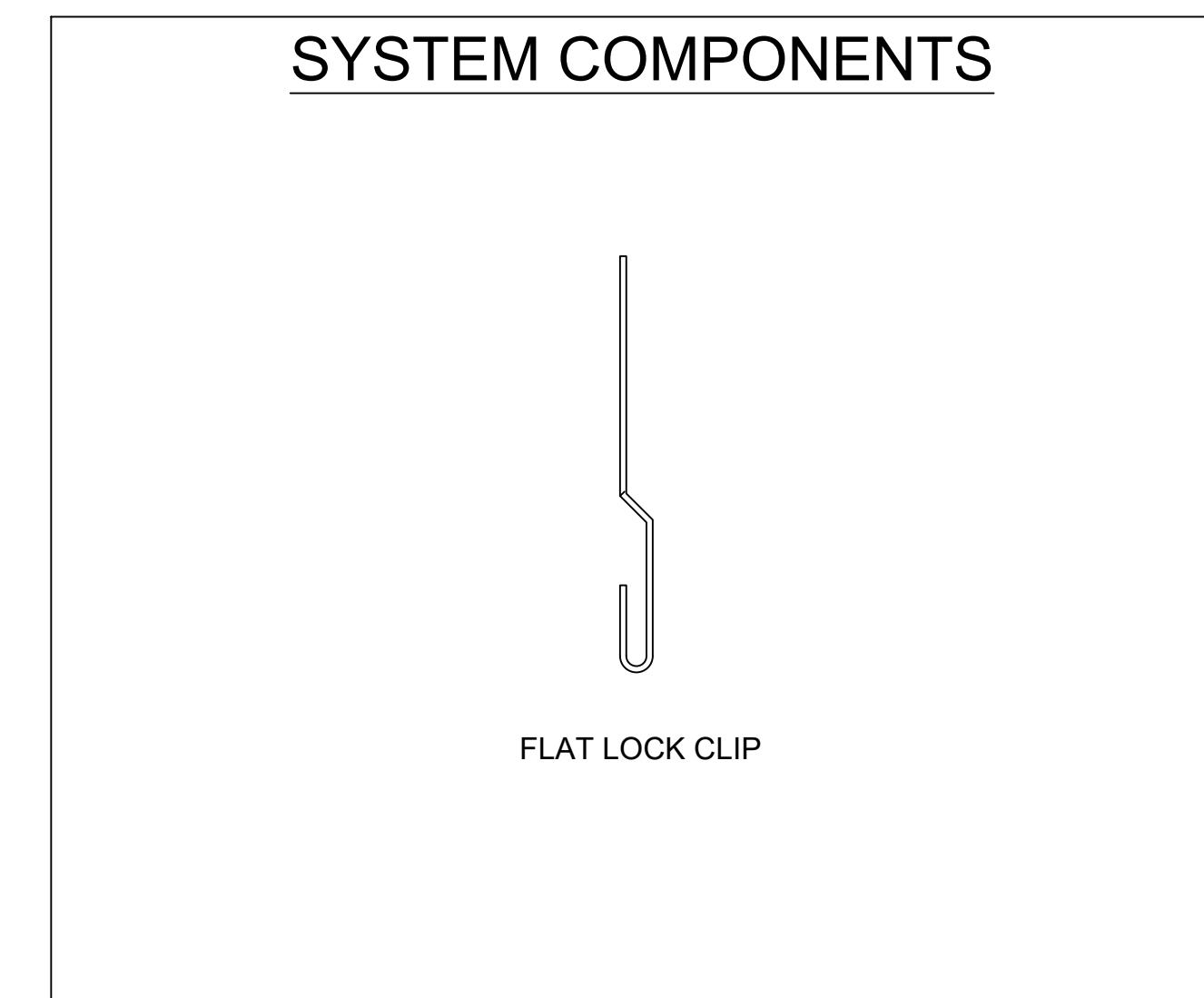
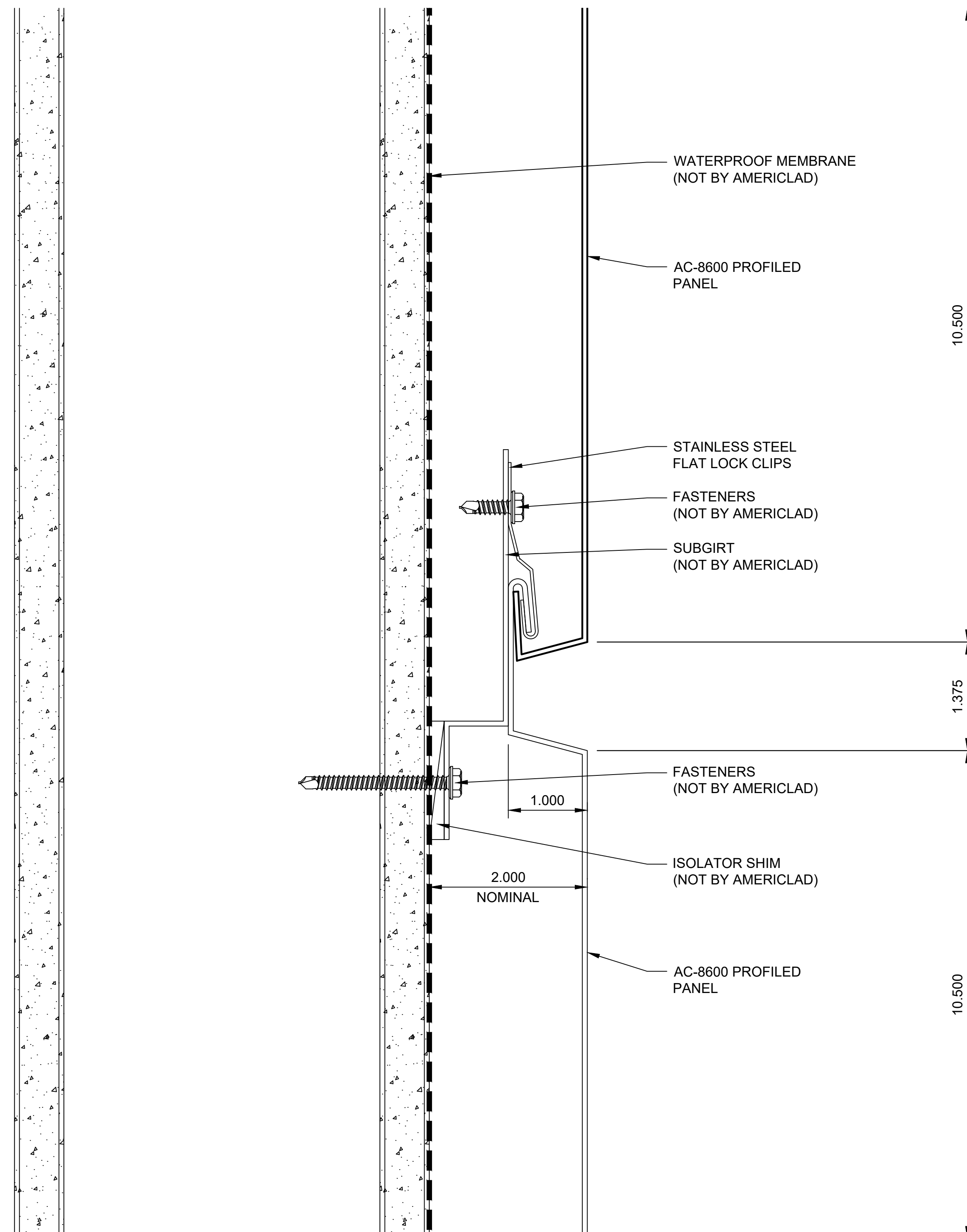

BASE DETAIL

DETAIL E

**NOTE:**  
**LOAD BEARING WALL COMPONENTS OF EITHER: 16GA STEEL STUDS, STRUCTURAL MEMBERS, MINIMUM 3/4" PLYWOOD OR CONCRETE. GYPSUM BOARD AND CEMENT BOARD ARE NOT A STRUCTURAL COMPONENT.**

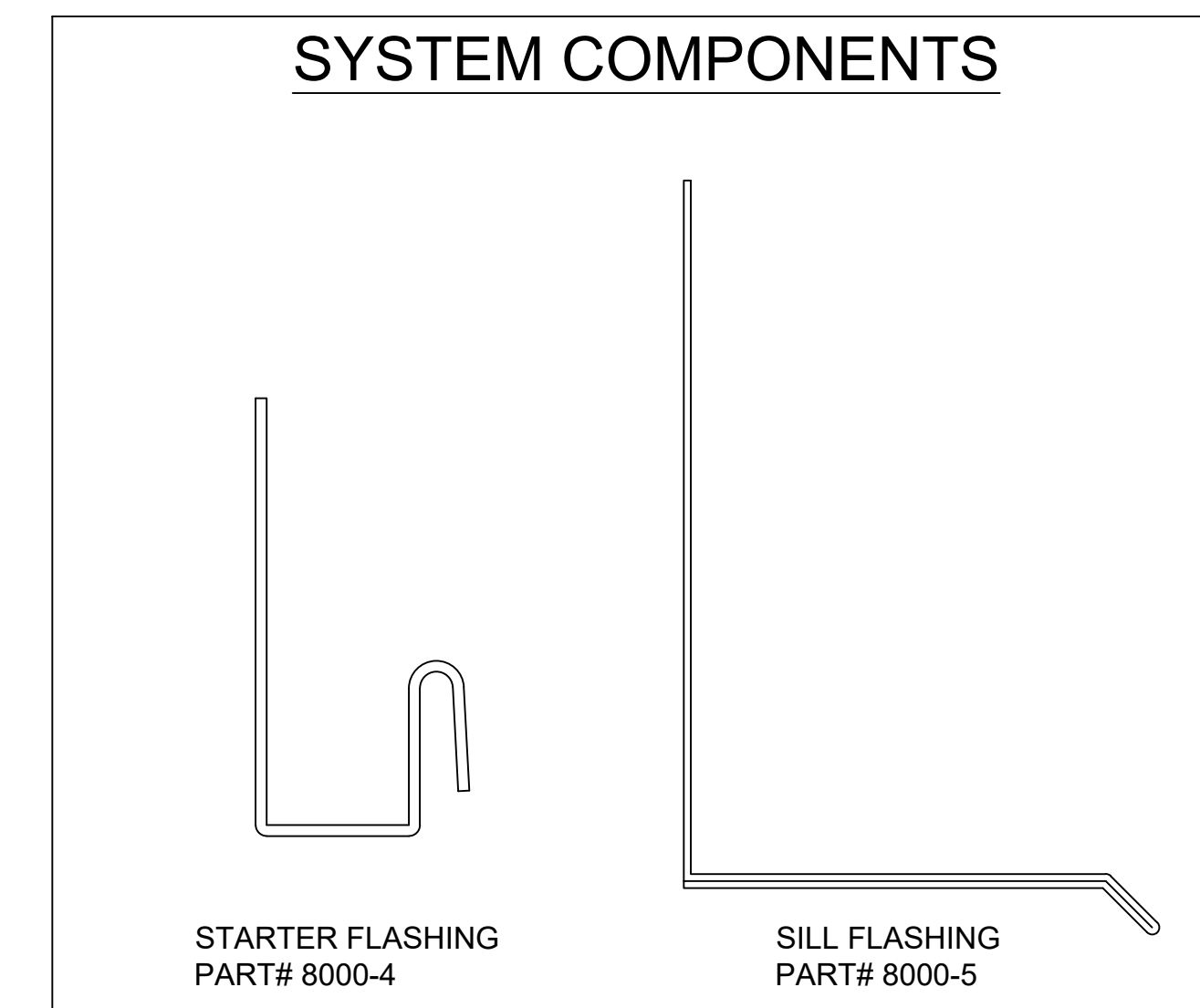
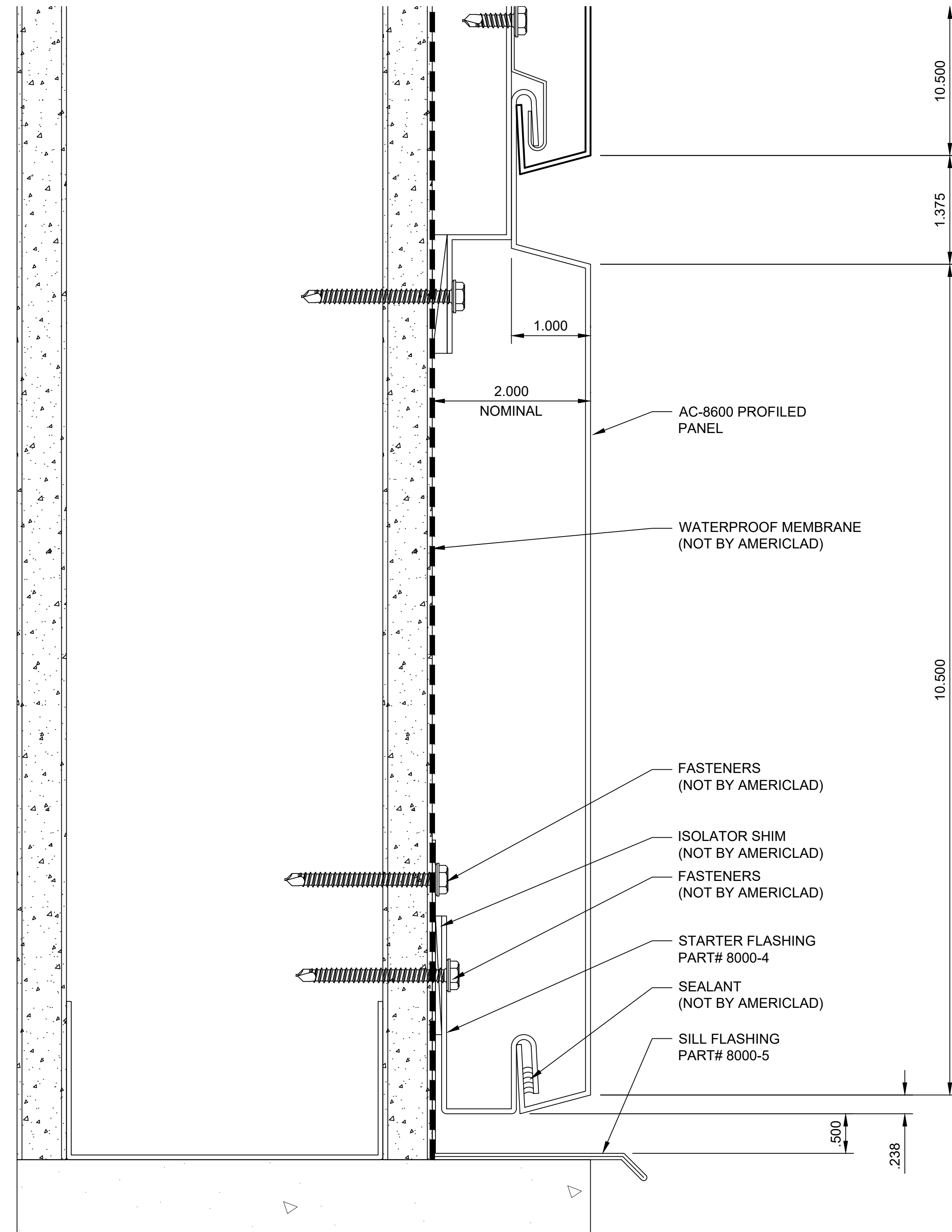

TERMINATION DETAIL

DETAIL F

**NOTE:**  
 LOAD BEARING WALL COMPONENTS OF EITHER: 16GA STEEL STUDS, STRUCTURAL MEMBERS, MINIMUM 3/4" PLYWOOD OR CONCRETE. GYPSUM BOARD AND CEMENT BOARD ARE NOT A STRUCTURAL COMPONENT.

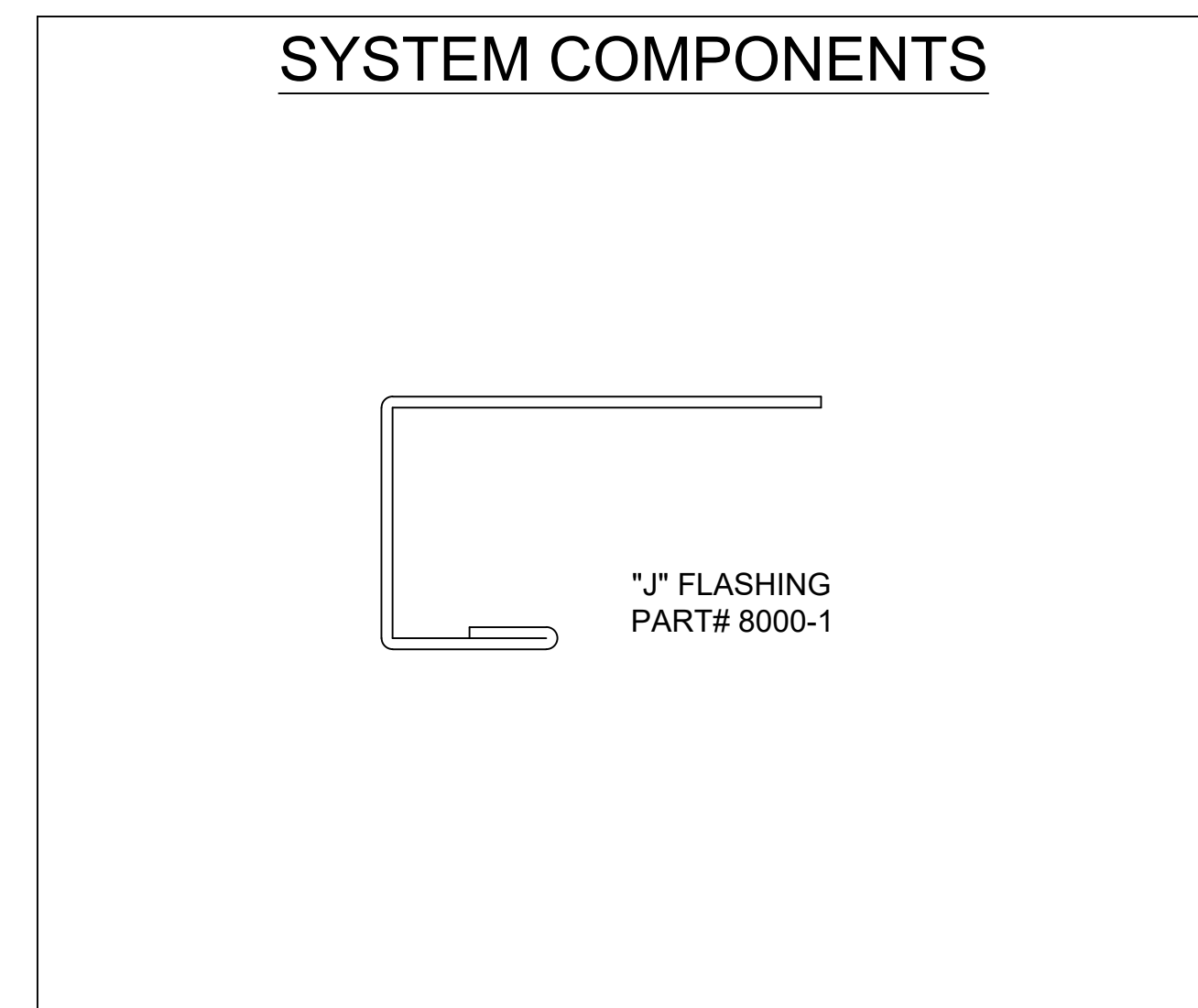
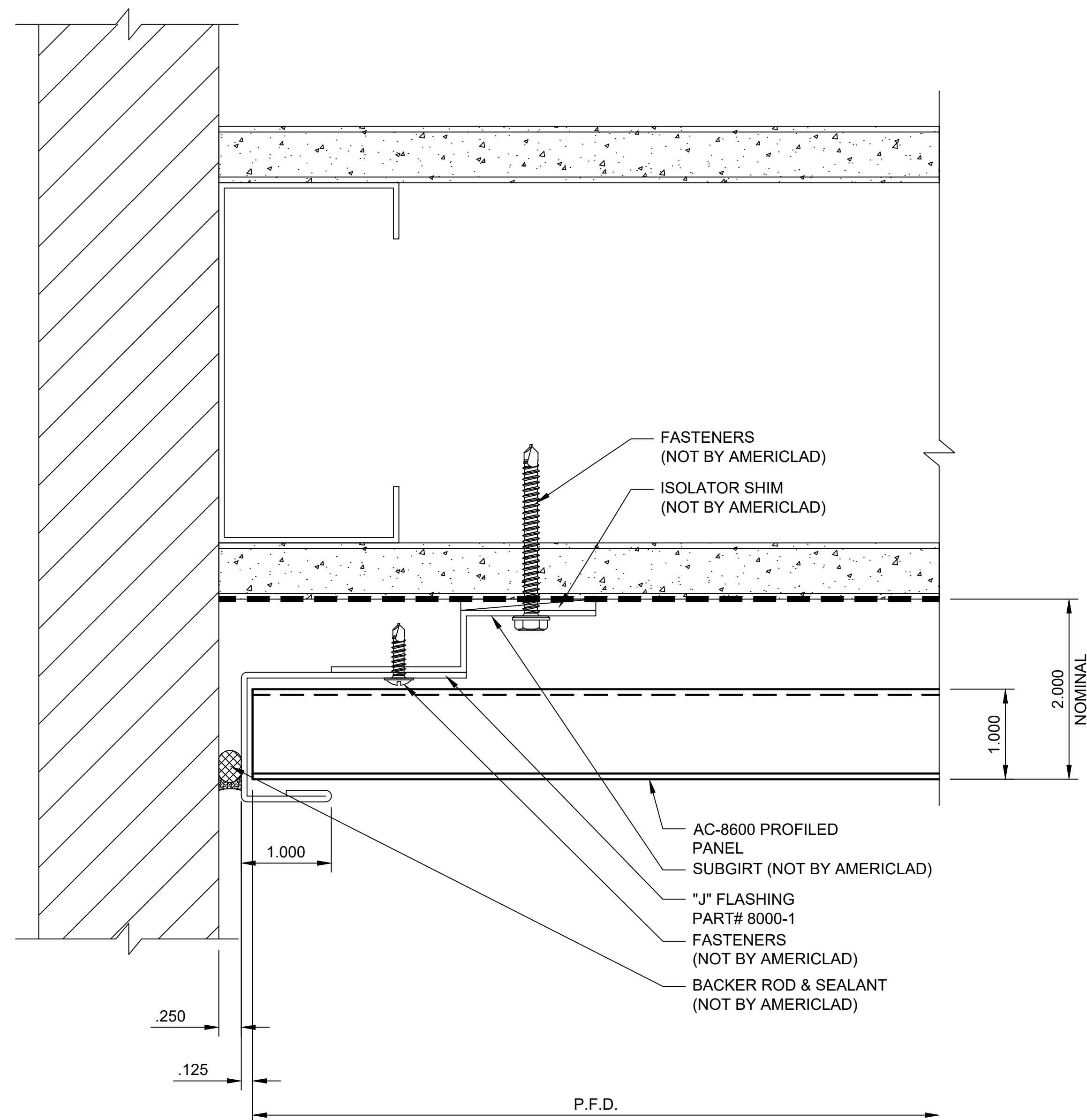

OUTSIDE CORNER PLAN DETAIL

DETAIL G

**NOTE:**  
LOAD BEARING WALL COMPONENTS OF EITHER: 16GA STEEL STUDS, STRUCTURAL MEMBERS, MINIMUM 3/4" PLYWOOD OR CONCRETE. GYPSUM BOARD AND CEMENT BOARD ARE NOT A STRUCTURAL COMPONENT.

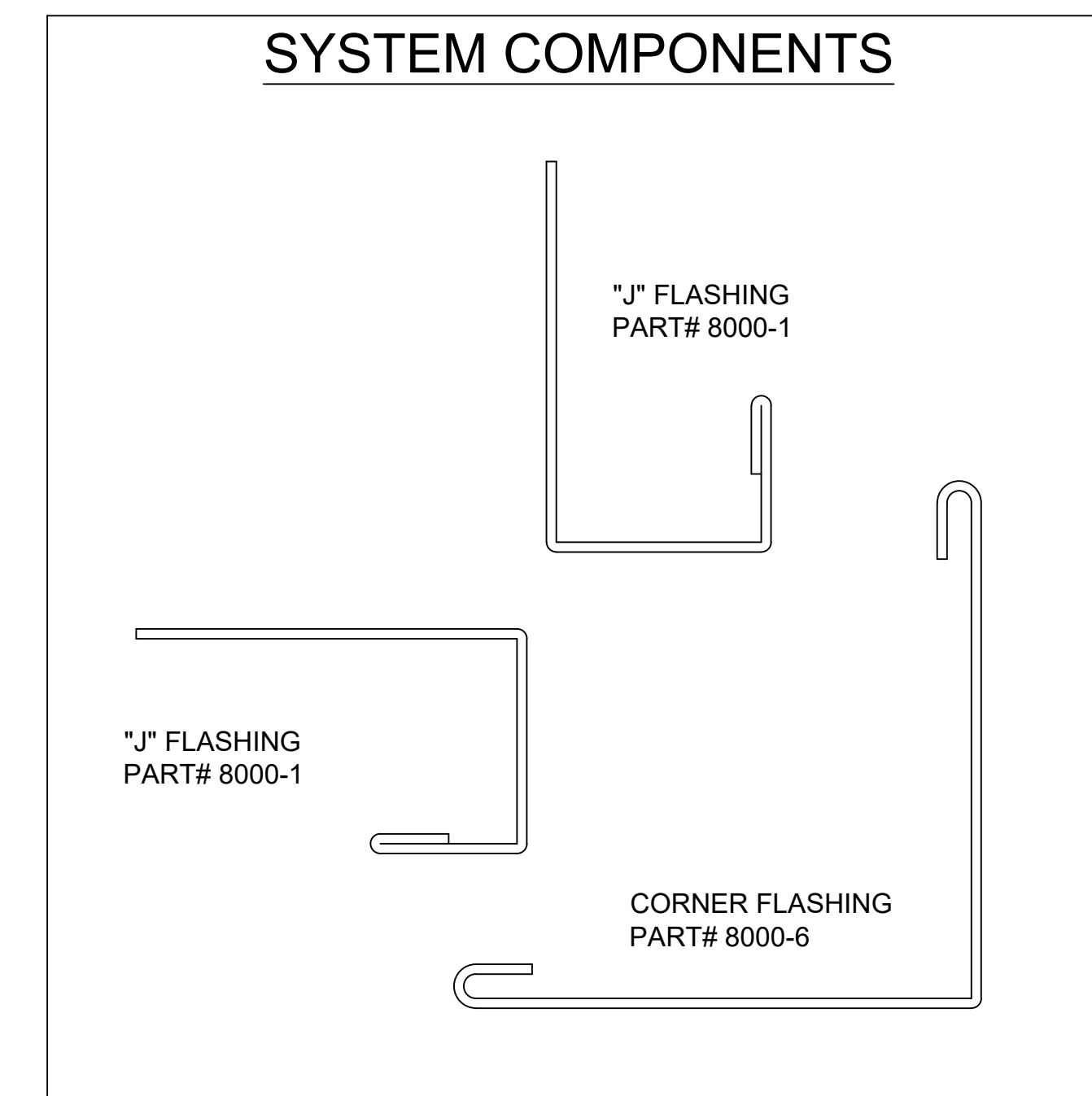
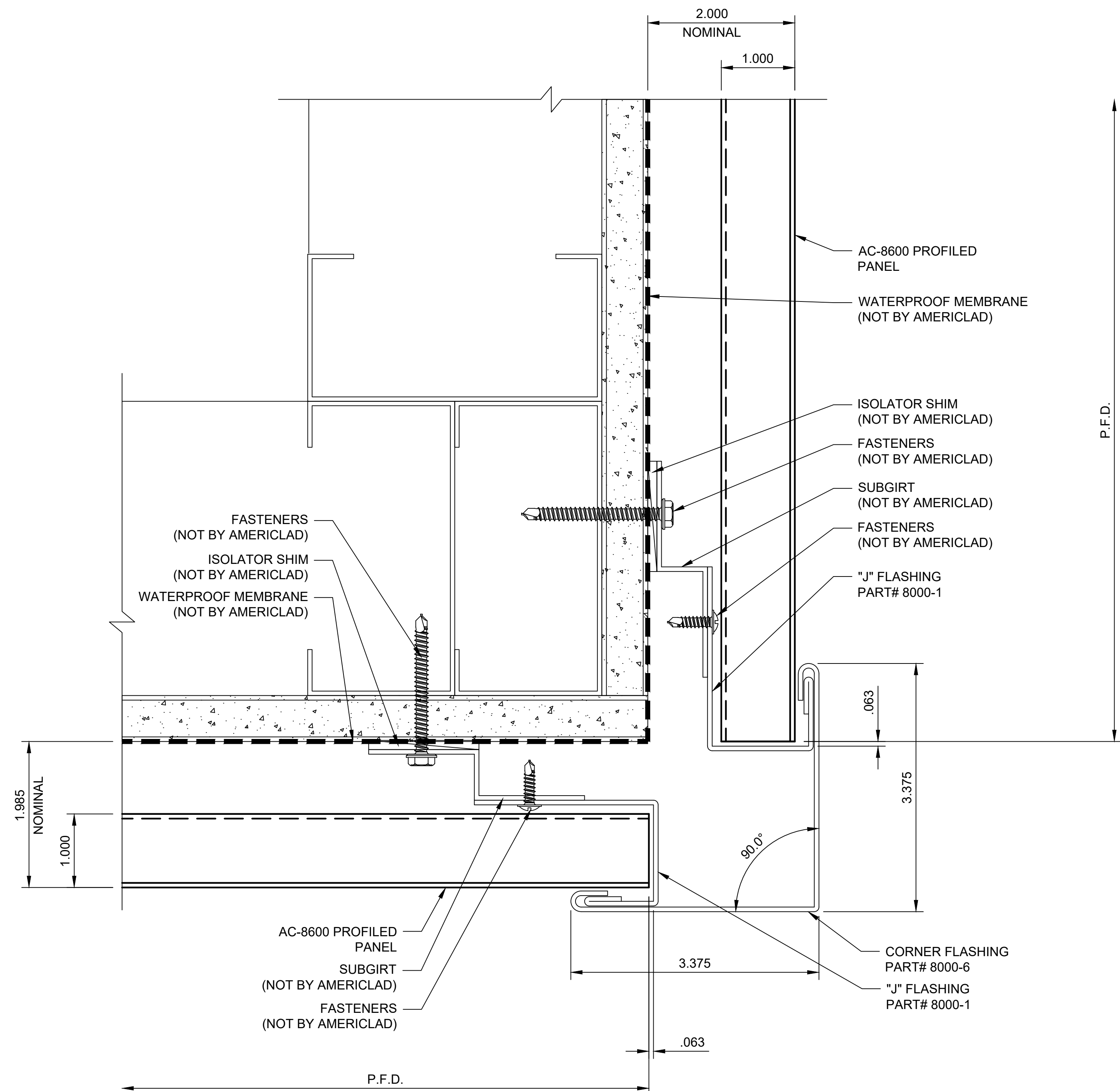



INSIDE CORNER PLAN DETAIL

DETAIL H

**NOTE:**  
 LOAD BEARING WALL COMPONENTS OF EITHER: 16GA STEEL STUDS, STRUCTURAL MEMBERS, MINIMUM 3/4" PLYWOOD OR CONCRETE. GYPSUM BOARD AND CEMENT BOARD ARE NOT A STRUCTURAL COMPONENT.

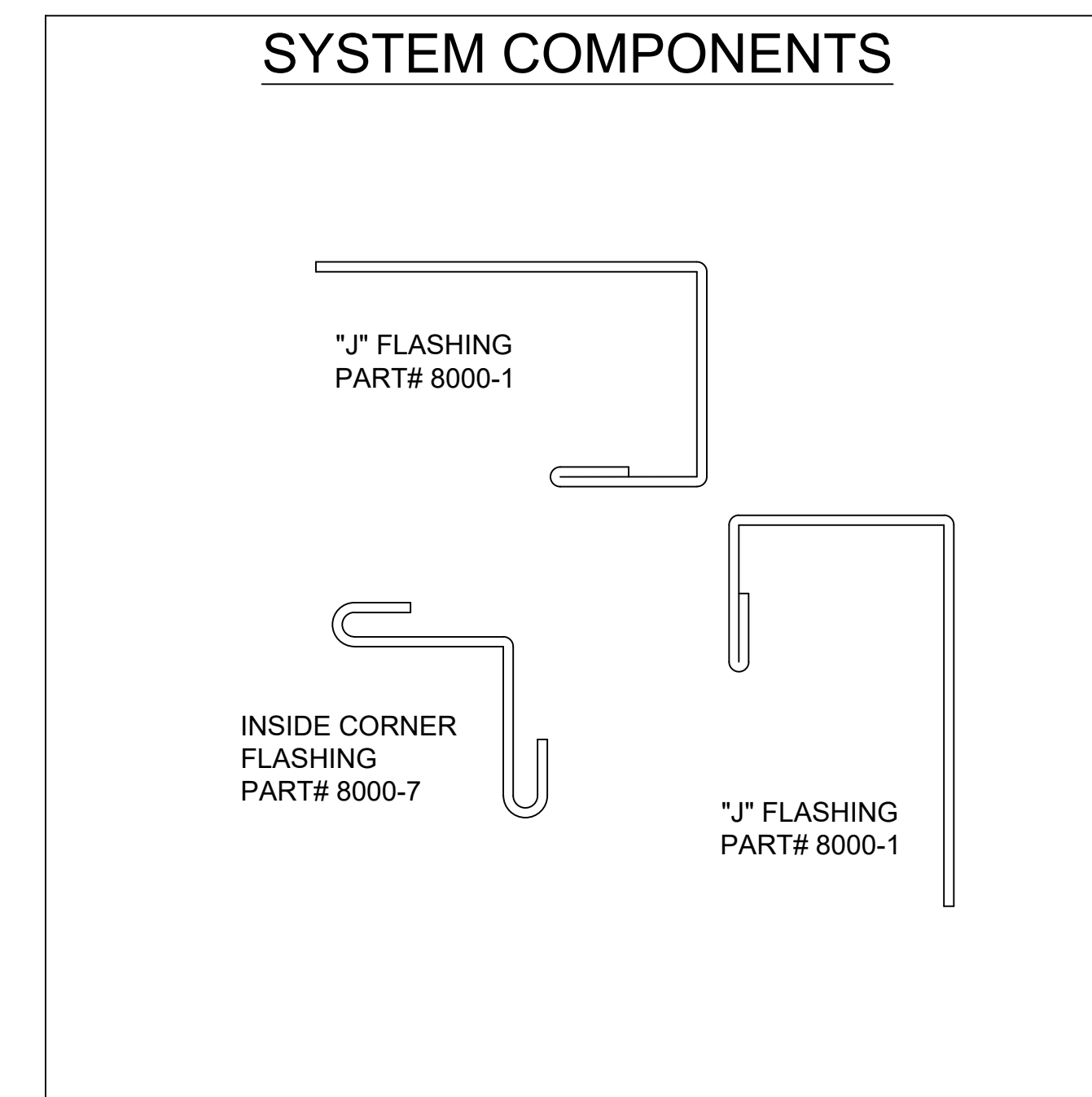
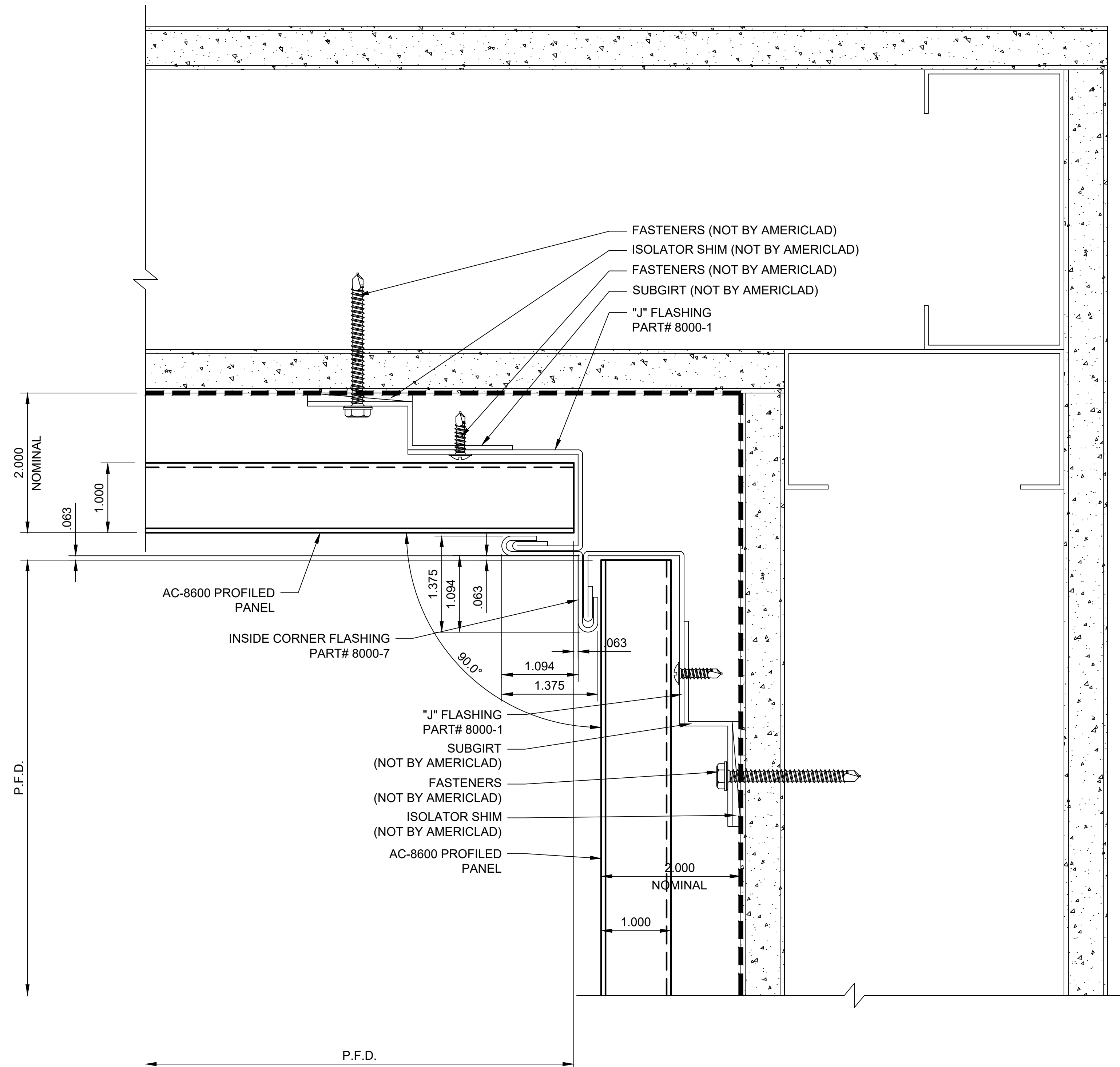

SECTION @ SOFFIT TRANSITION

DETAIL J

**NOTE:**  
LOAD BEARING WALL COMPONENTS OF EITHER: 16GA STEEL STUDS, STRUCTURAL MEMBERS, MINIMUM 3/4" PLYWOOD OR CONCRETE. GYPSUM BOARD AND CEMENT BOARD ARE NOT A STRUCTURAL COMPONENT.

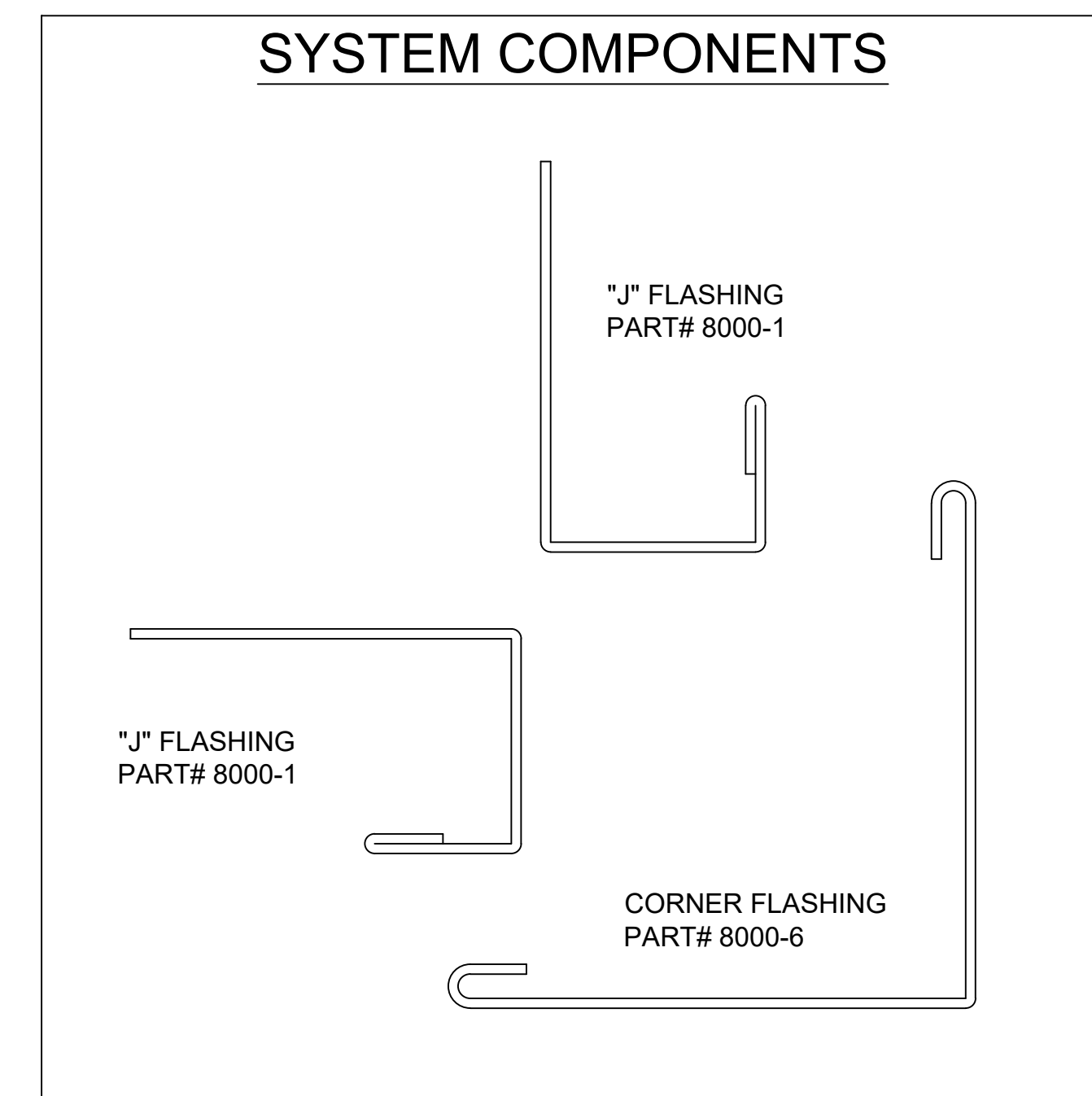
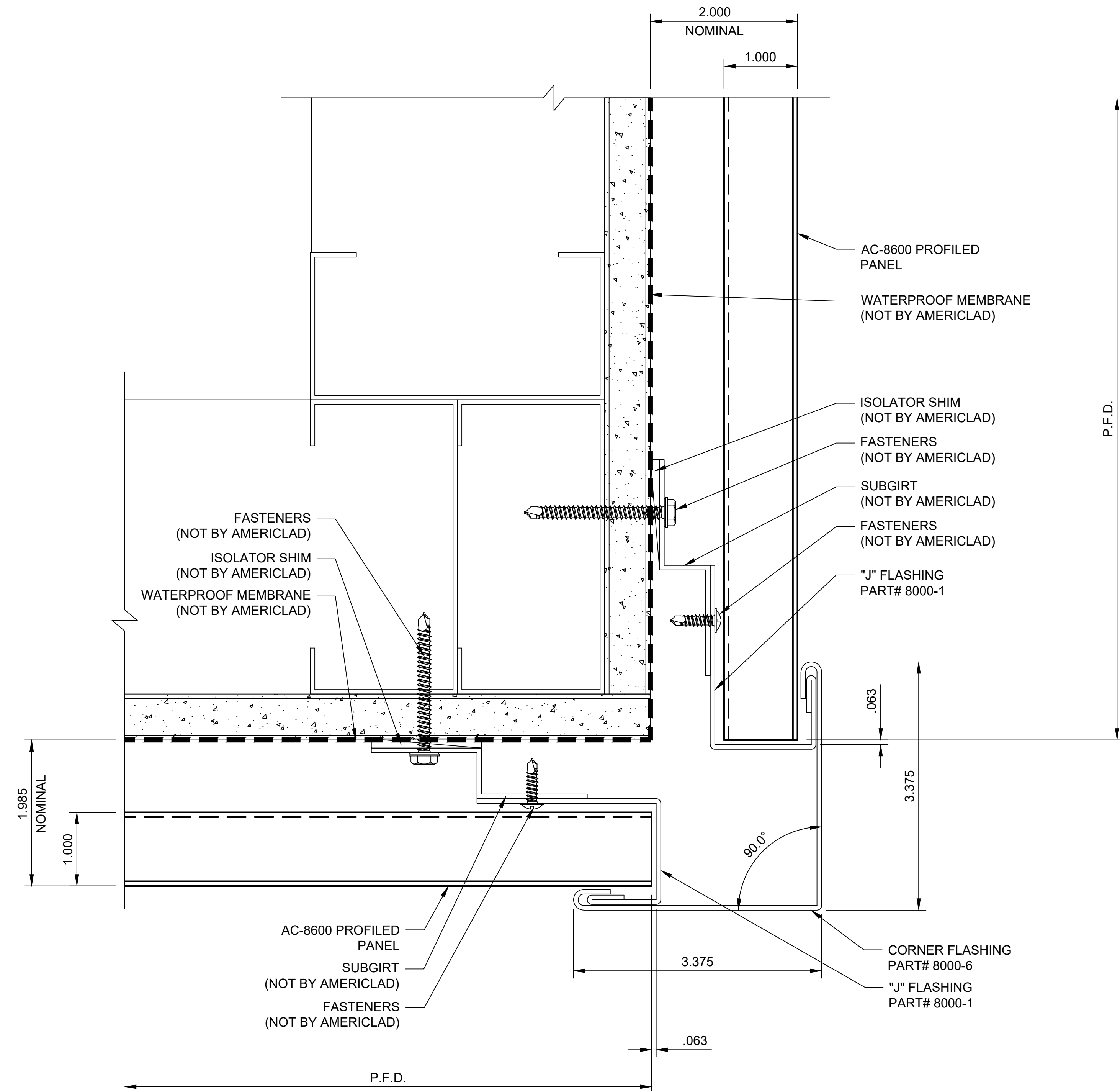

SECTION @ SOFFIT

DETAIL K

**NOTE:**  
 LOAD BEARING WALL COMPONENTS OF EITHER: 16GA STEEL STUDS, STRUCTURAL MEMBERS, MINIMUM 3/4" PLYWOOD OR CONCRETE. GYPSUM BOARD AND CEMENT BOARD ARE NOT A STRUCTURAL COMPONENT.

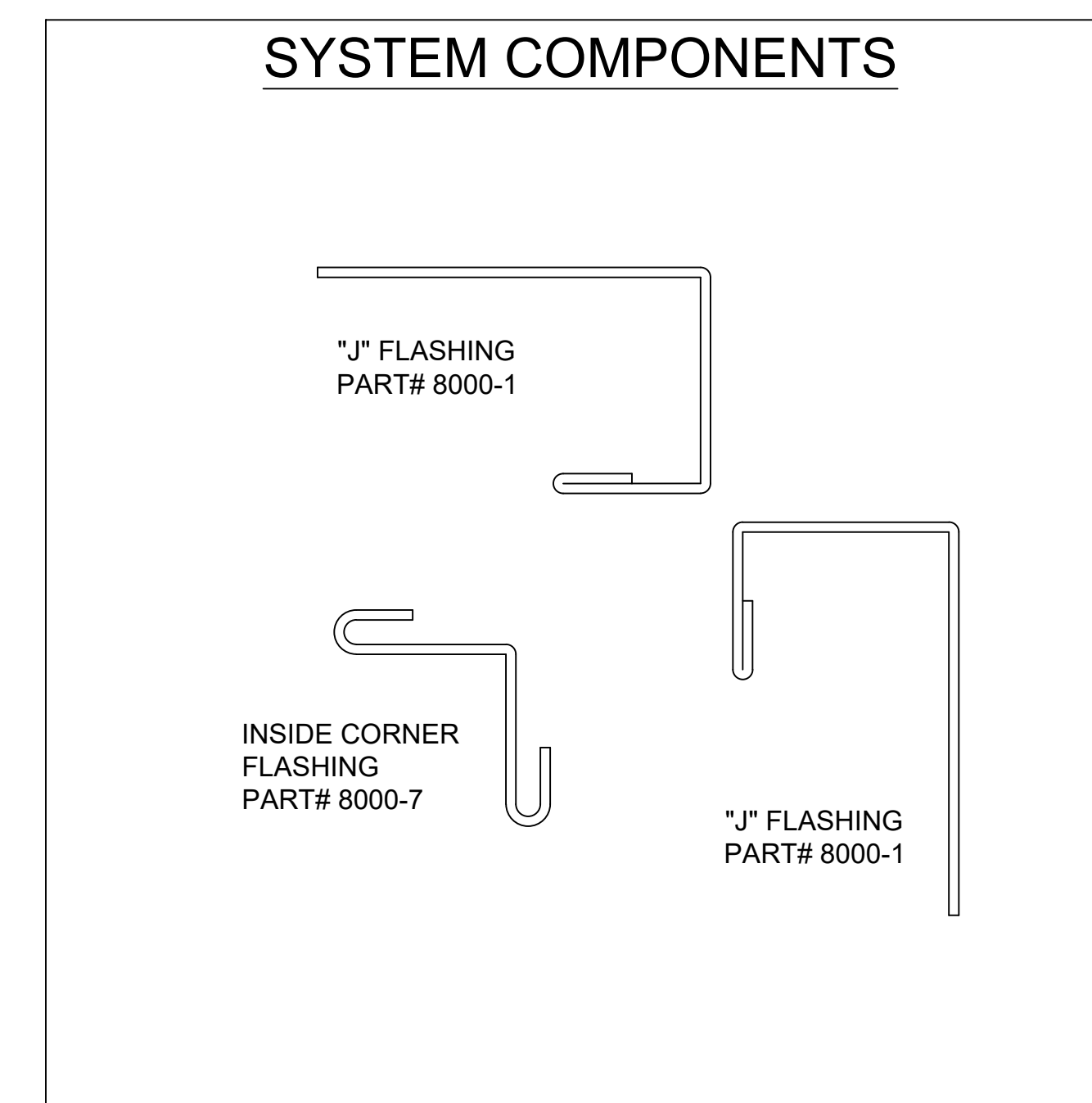
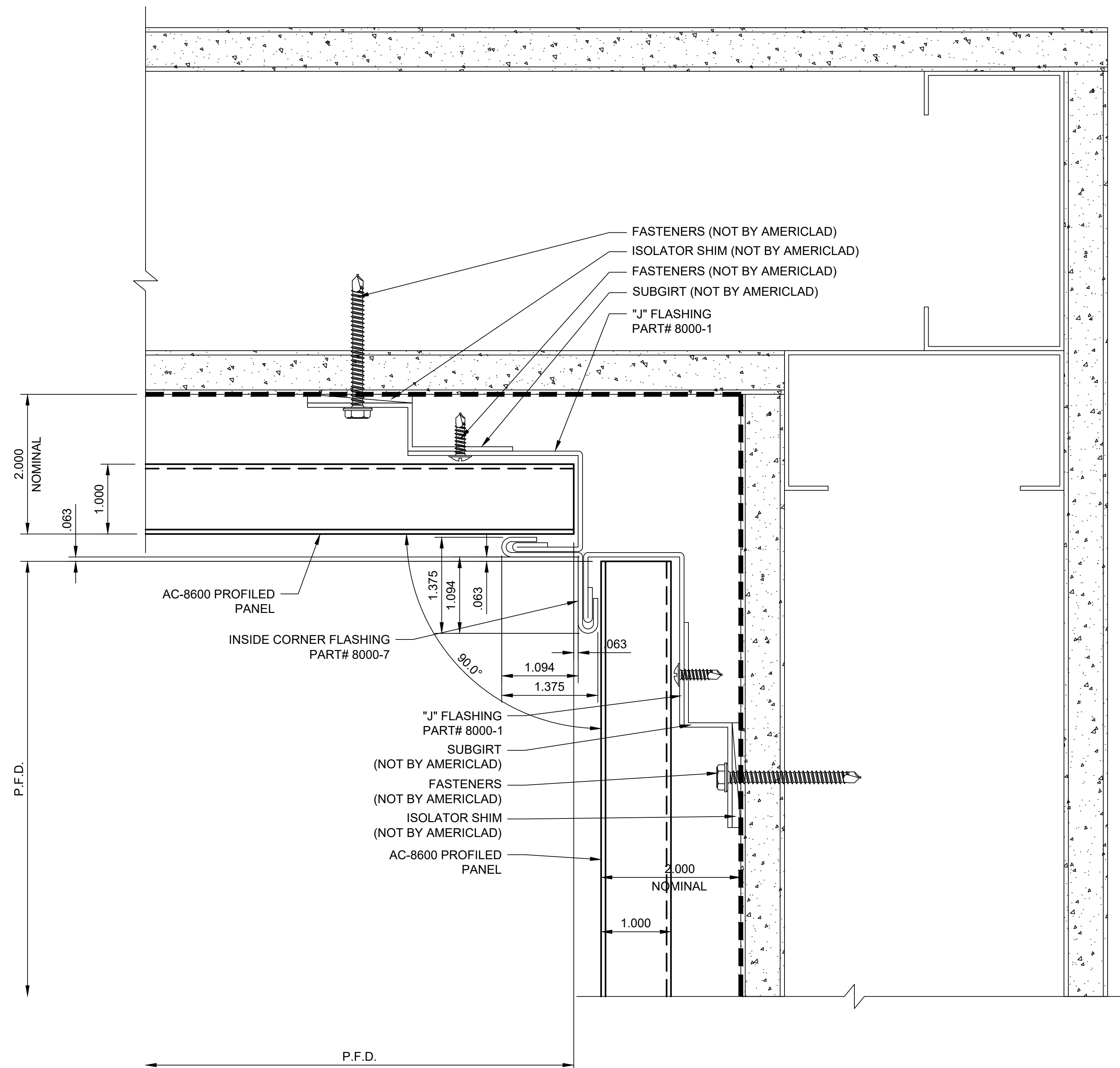

WINDOW SILL DETAIL

DETAIL L

**NOTE:**  
 LOAD BEARING WALL COMPONENTS OF EITHER: 16GA STEEL STUDS, STRUCTURAL MEMBERS, MINIMUM 3/4" PLYWOOD OR CONCRETE. GYPSUM BOARD AND CEMENT BOARD ARE NOT A STRUCTURAL COMPONENT.

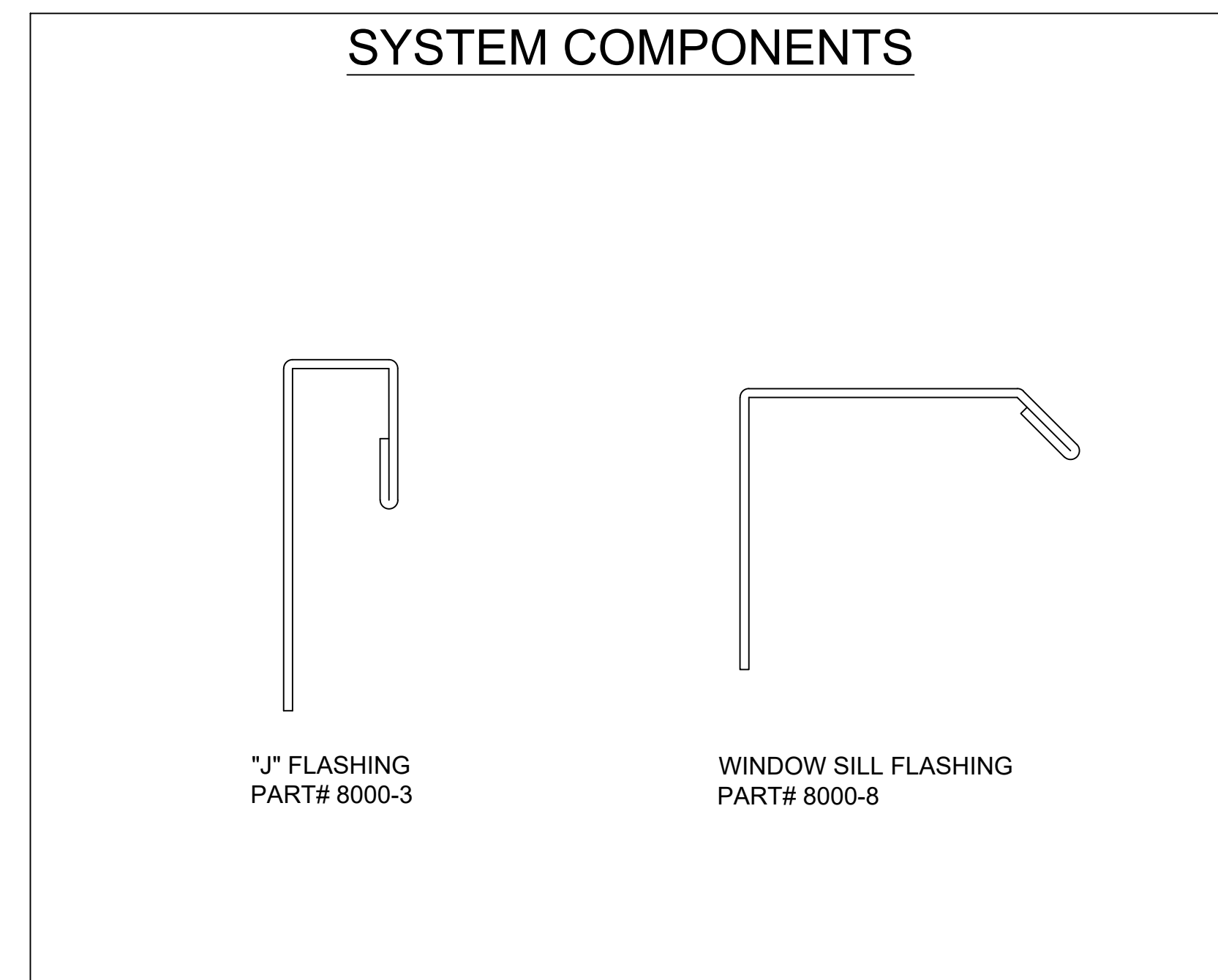
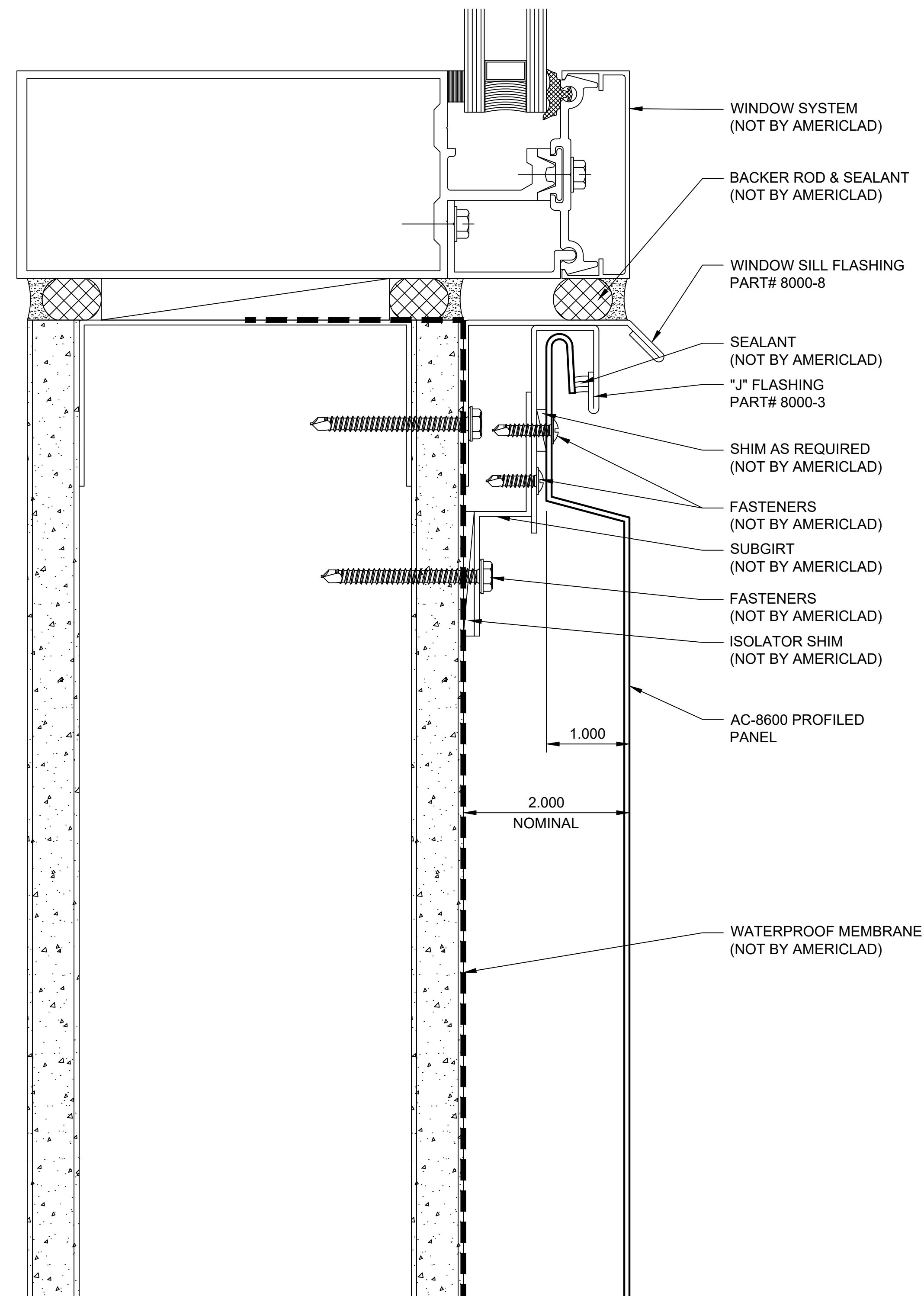

WINDOW HEAD DETAIL

DETAIL M

**NOTE:**  
 LOAD BEARING WALL COMPONENTS OF EITHER: 16GA STEEL STUDS, STRUCTURAL MEMBERS, MINIMUM 3/4" PLYWOOD OR CONCRETE. GYPSUM BOARD AND CEMENT BOARD ARE NOT A STRUCTURAL COMPONENT.

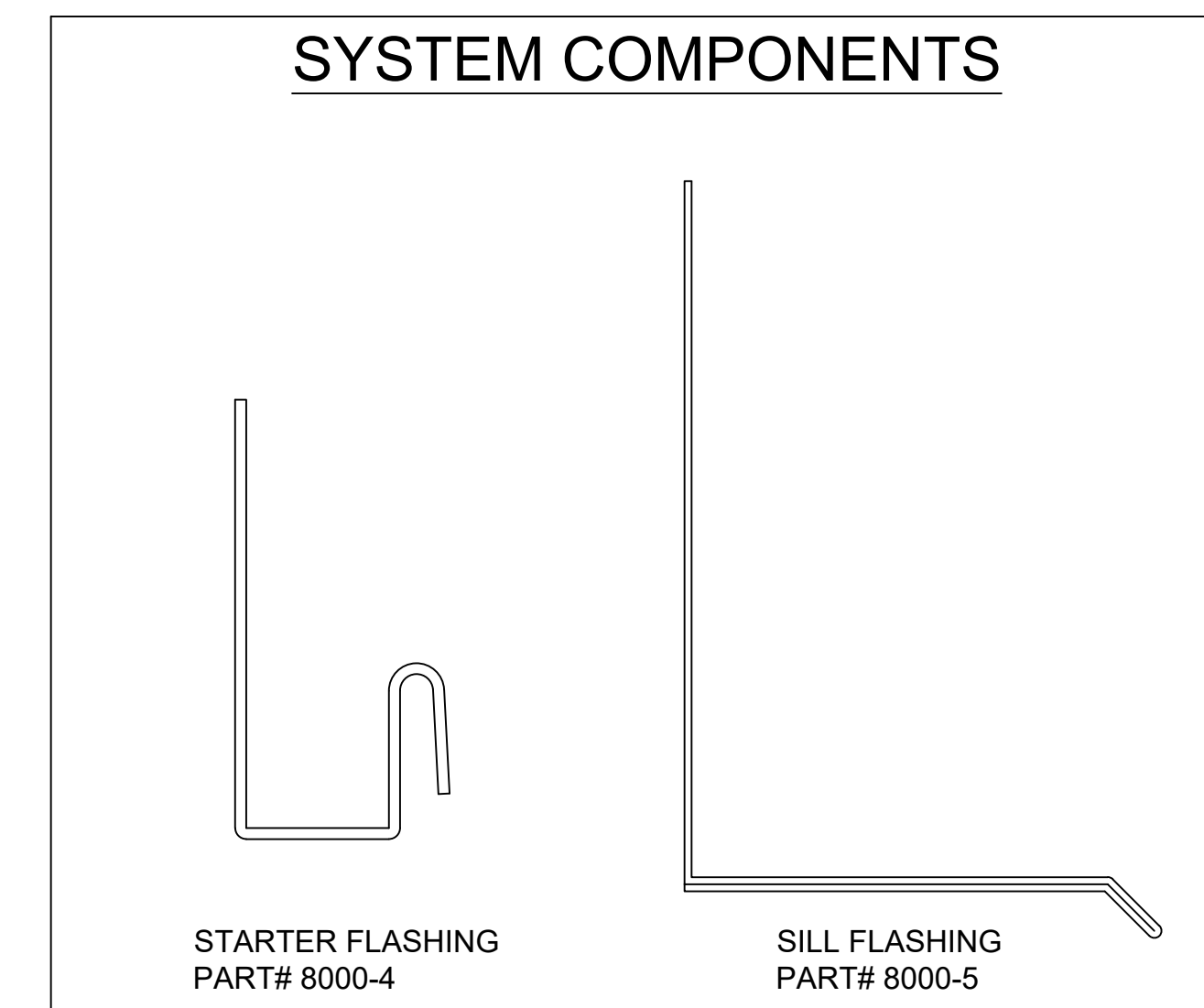
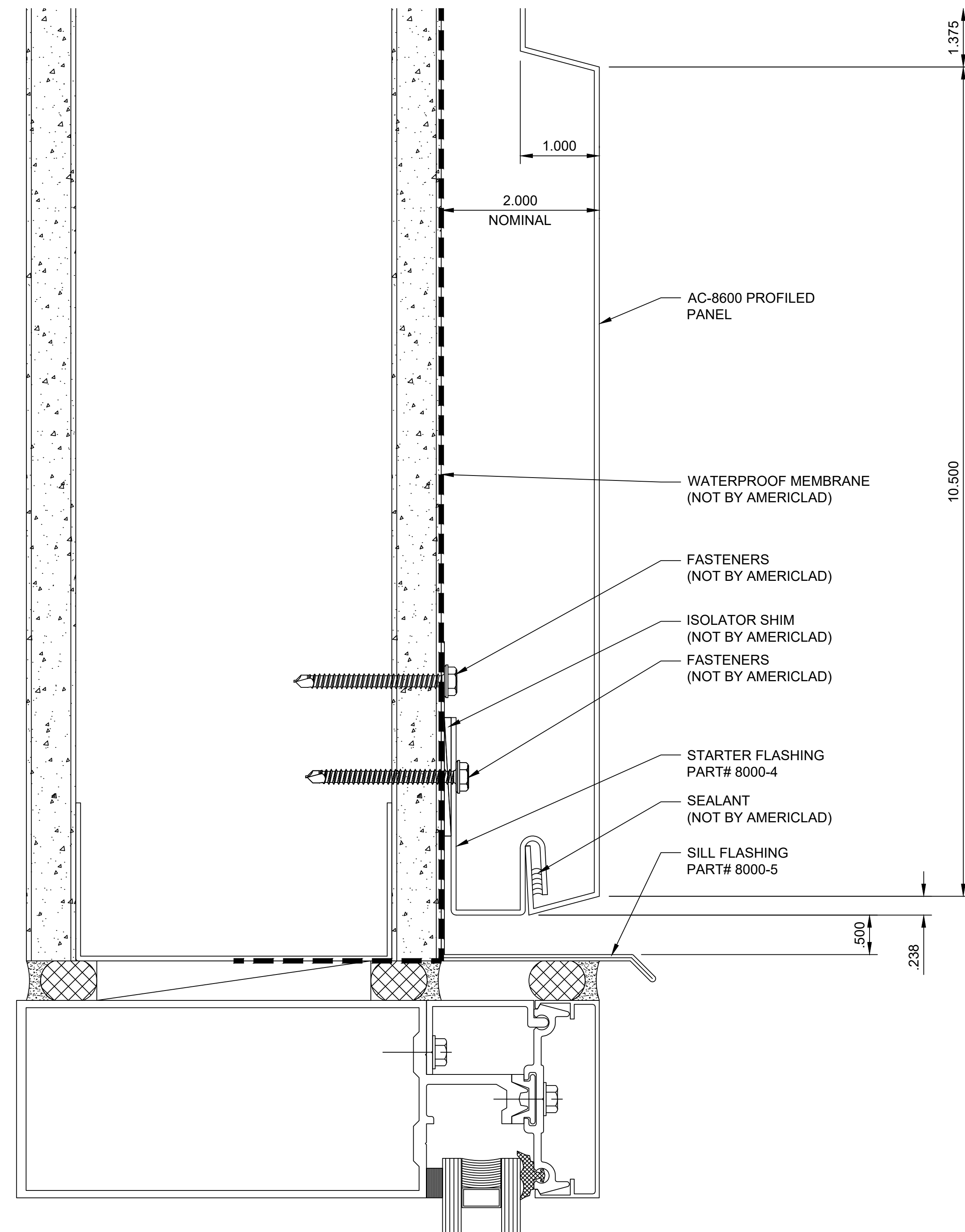

WINDOW JAMB DETAIL

DETAIL N

**NOTE:**  
 LOAD BEARING WALL COMPONENTS OF EITHER: 16GA STEEL STUDS, STRUCTURAL MEMBERS, MINIMUM 3/4" PLYWOOD OR CONCRETE. GYPSUM BOARD AND CEMENT BOARD ARE NOT A STRUCTURAL COMPONENT.

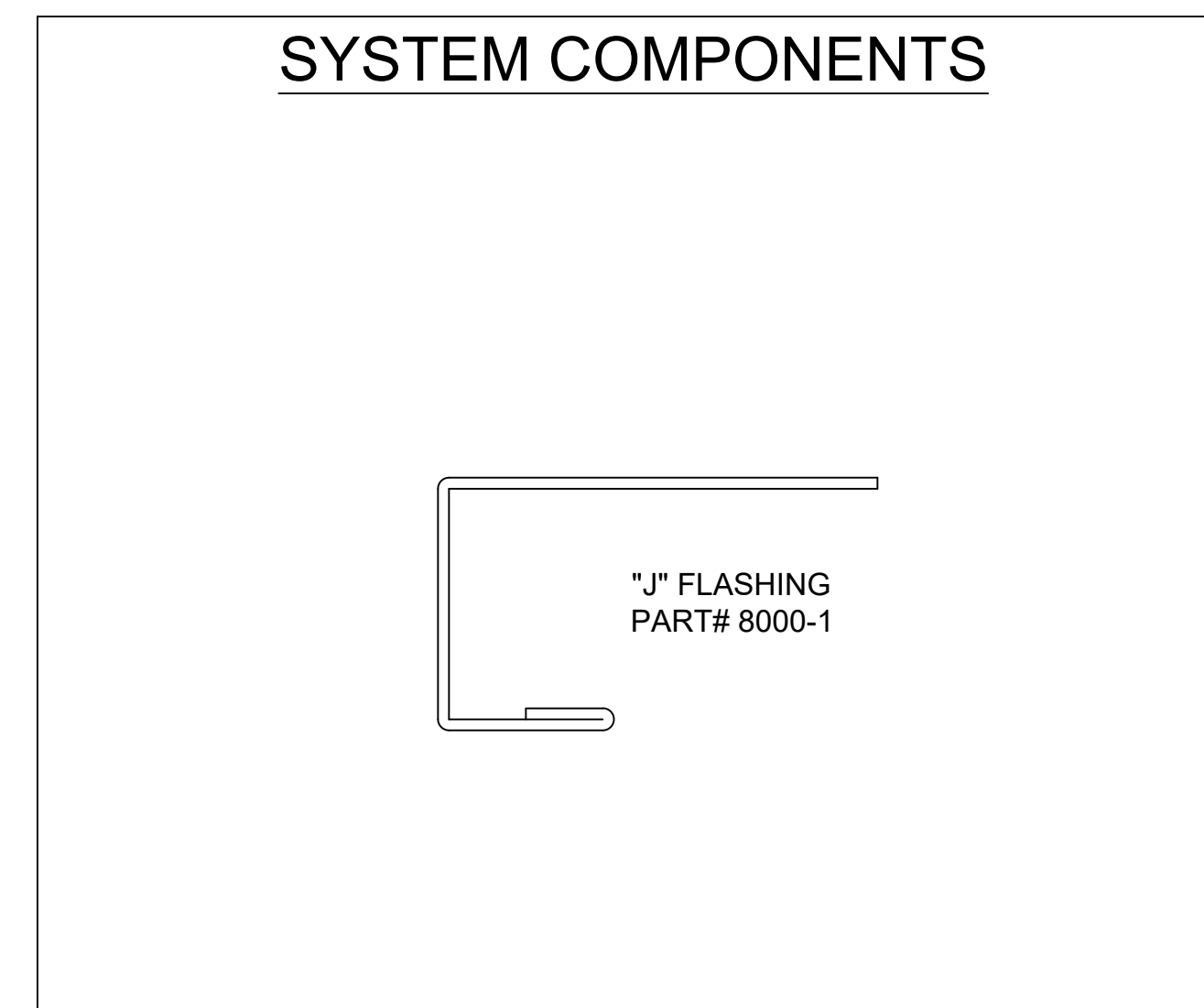
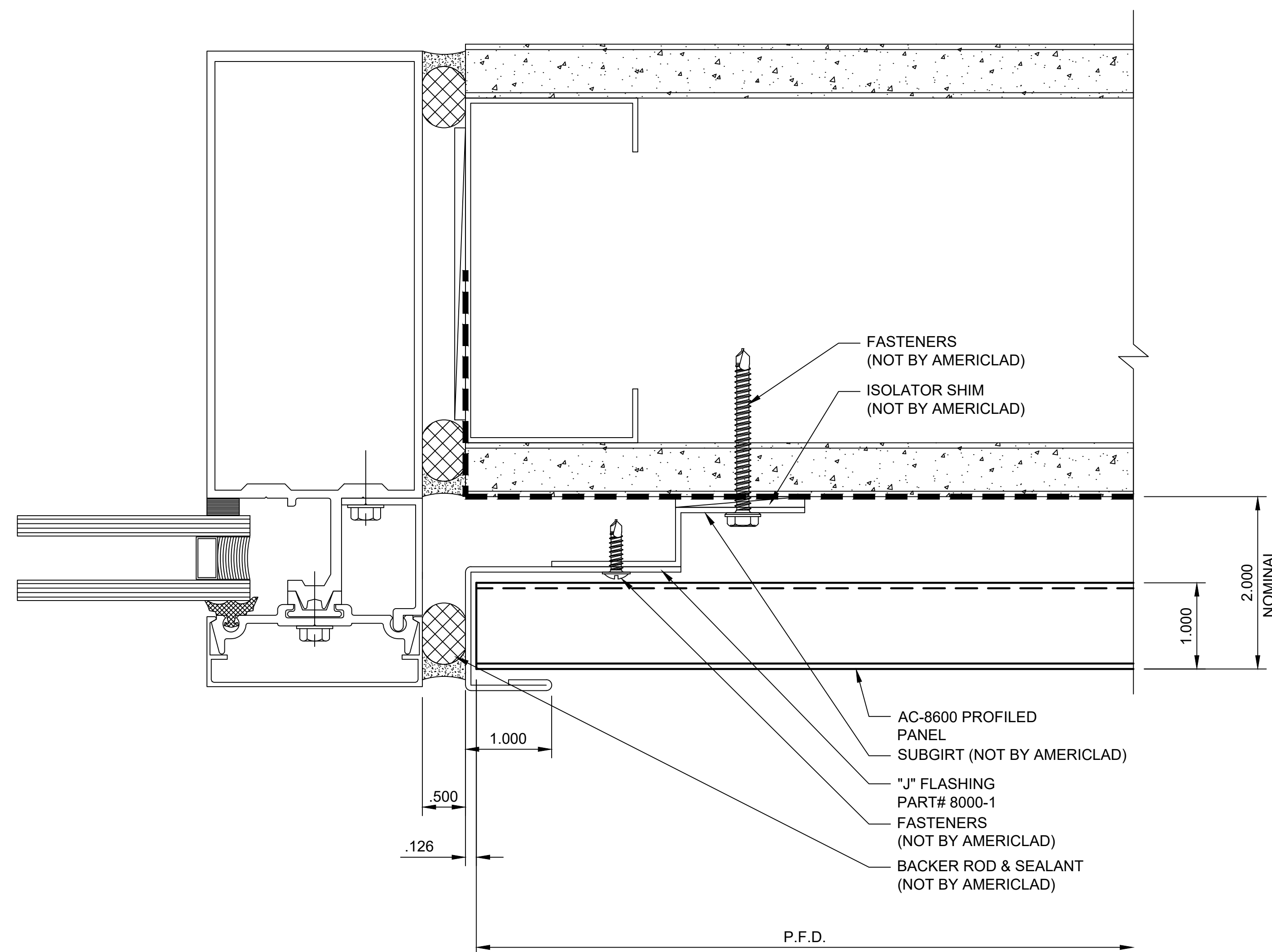

FLASHING PROFILES

DETAIL O

**NOTE:**

LOAD BEARING WALL COMPONENTS OF EITHER: 16GA STEEL STUDS, STRUCTURAL MEMBERS, MINIMUM 3/4" PLYWOOD OR CONCRETE. GYPSUM BOARD AND CEMENT BOARD ARE NOT A STRUCTURAL COMPONENT.

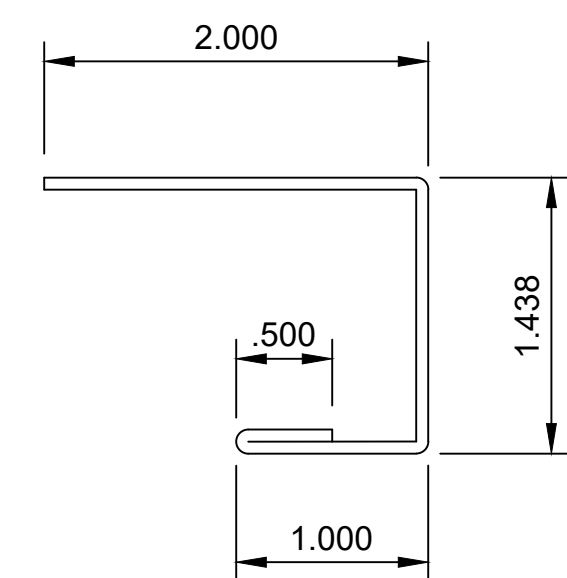

"J" FLASHING  
PART# 8000-1  
**QTY:**  
10'-0" STOCK LENGTHS

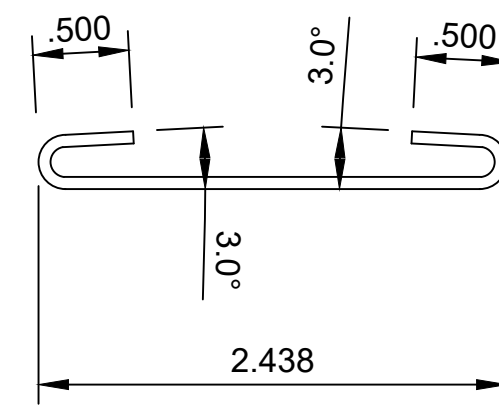

COVER FLASHING  
PART# 8000-2  
**QTY:**  
10'-0" STOCK LENGTHS

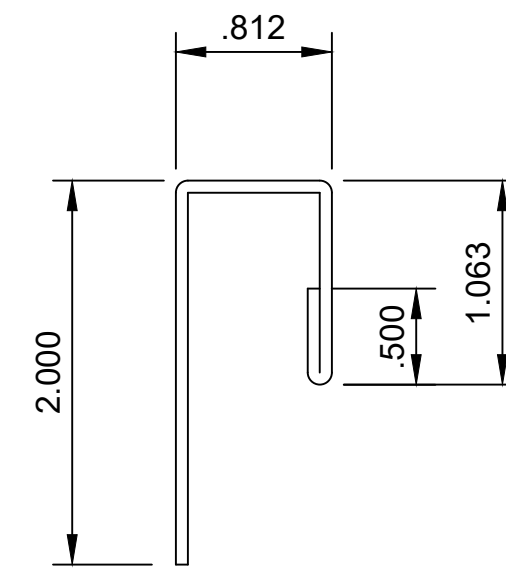

"J" FLASHING  
PART# 8000-3  
**QTY:**  
10'-0" STOCK LENGTHS

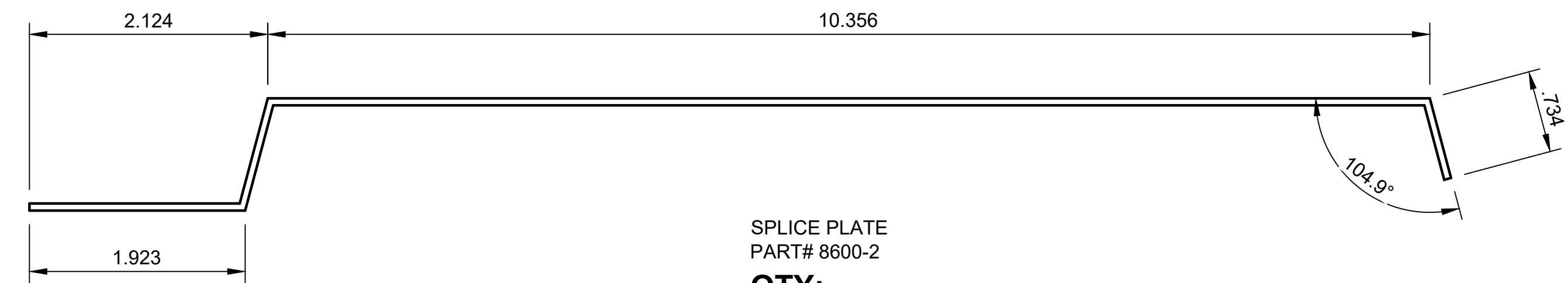

SPLICE PLATE  
PART# 8600-2  
**QTY:**  
6" LENGTHS

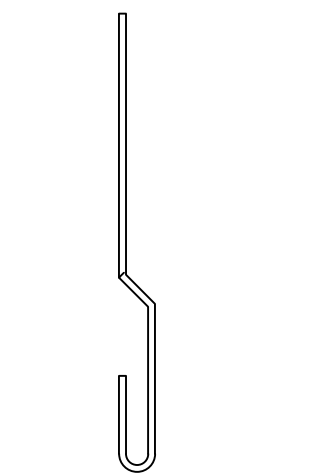

FLAT LOCK CLIP

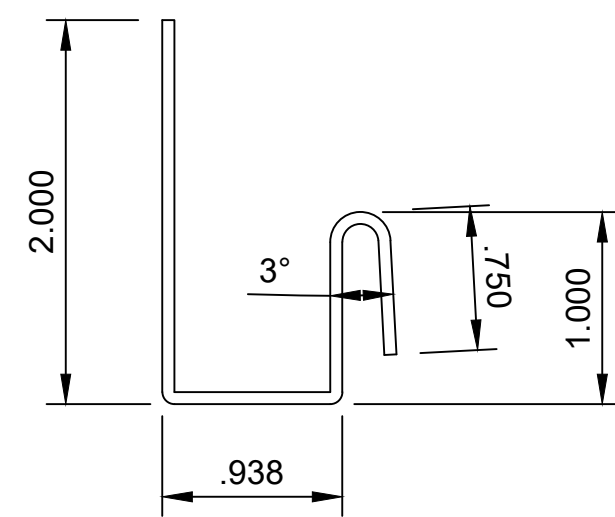

STARTER FLASHING  
PART# 8000-4  
**QTY:**  
10'-0" STOCK LENGTHS

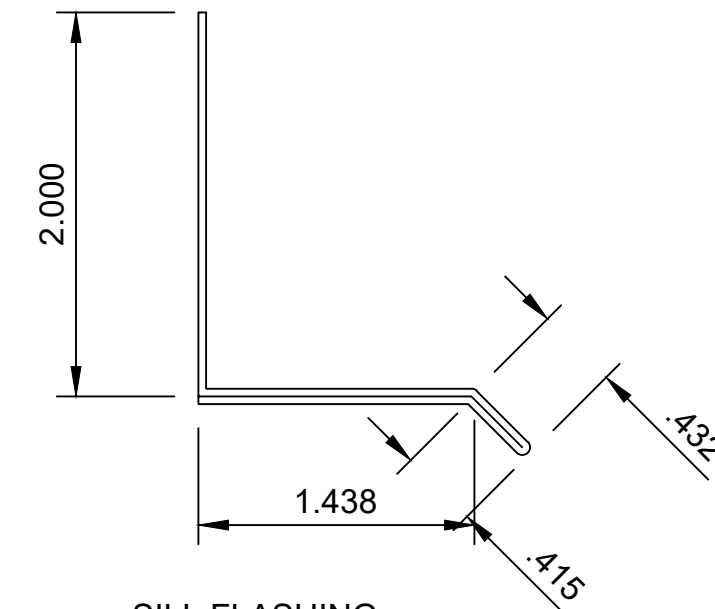

SILL FLASHING  
PART# 8000-5  
**QTY:**  
10'-0" STOCK LENGTHS

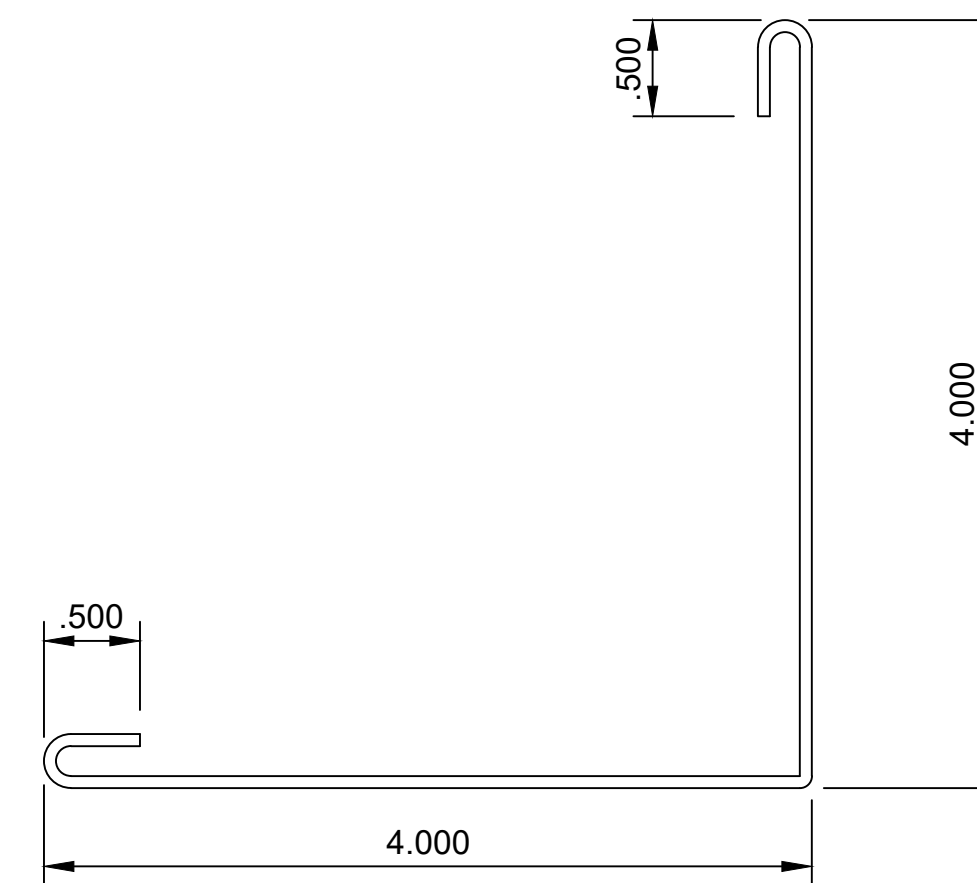

CORNER FLASHING  
PART# 8000-6  
**QTY:**  
10'-0" STOCK LENGTHS

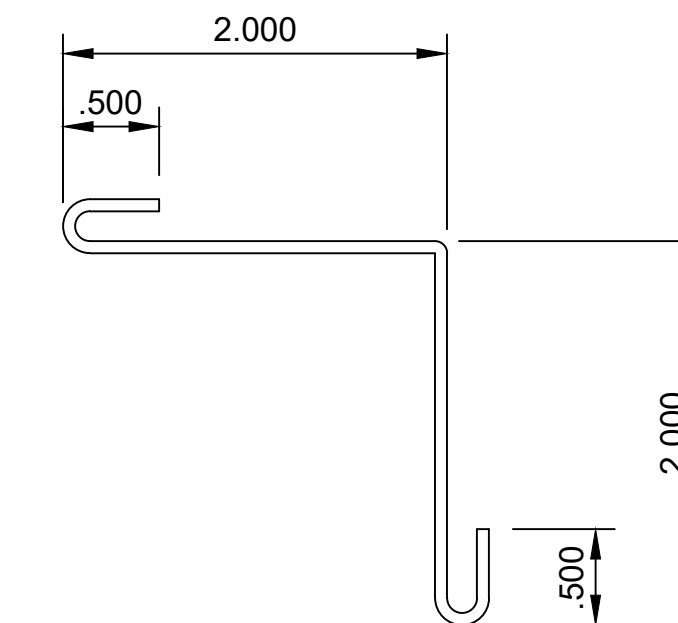

INSIDE CORNER  
FLASHING  
PART# 8000-7  
**QTY:**  
10'-0" STOCK LENGTHS

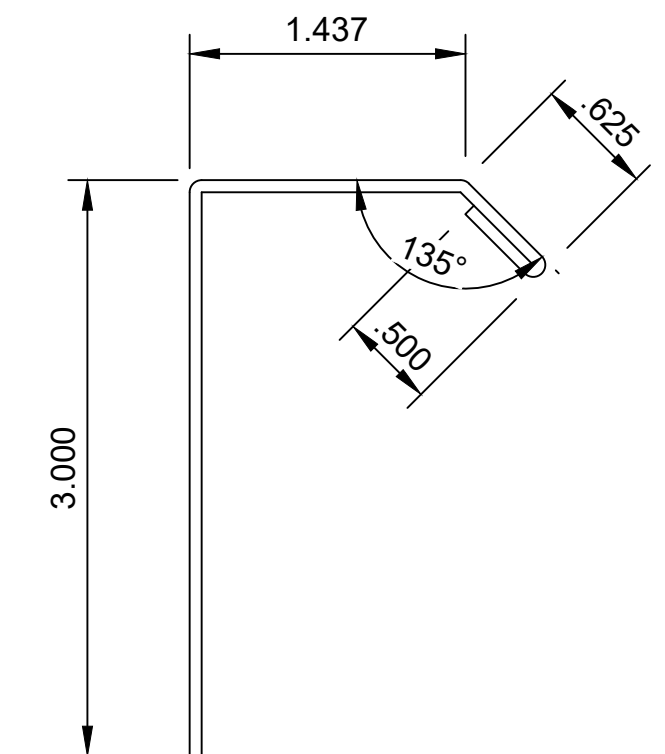

WINDOW SILL FLASHING  
PART# 8000-8  
**QTY:**  
10'-0" STOCK LENGTHS

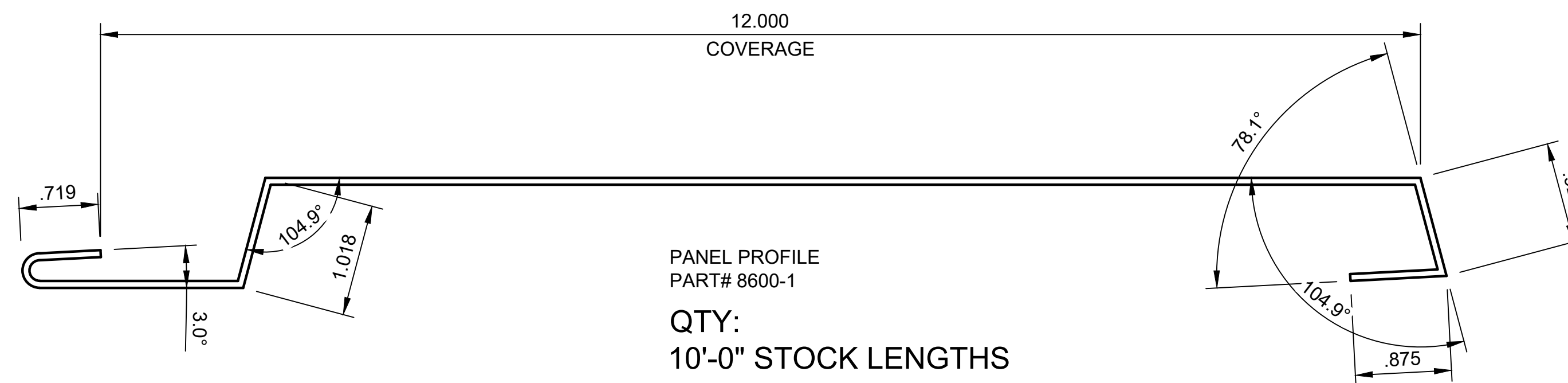

PANEL PROFILE  
PART# 8600-1  
**QTY:**  
10'-0" STOCK LENGTHS